

Intelligent Solutions For Your Success

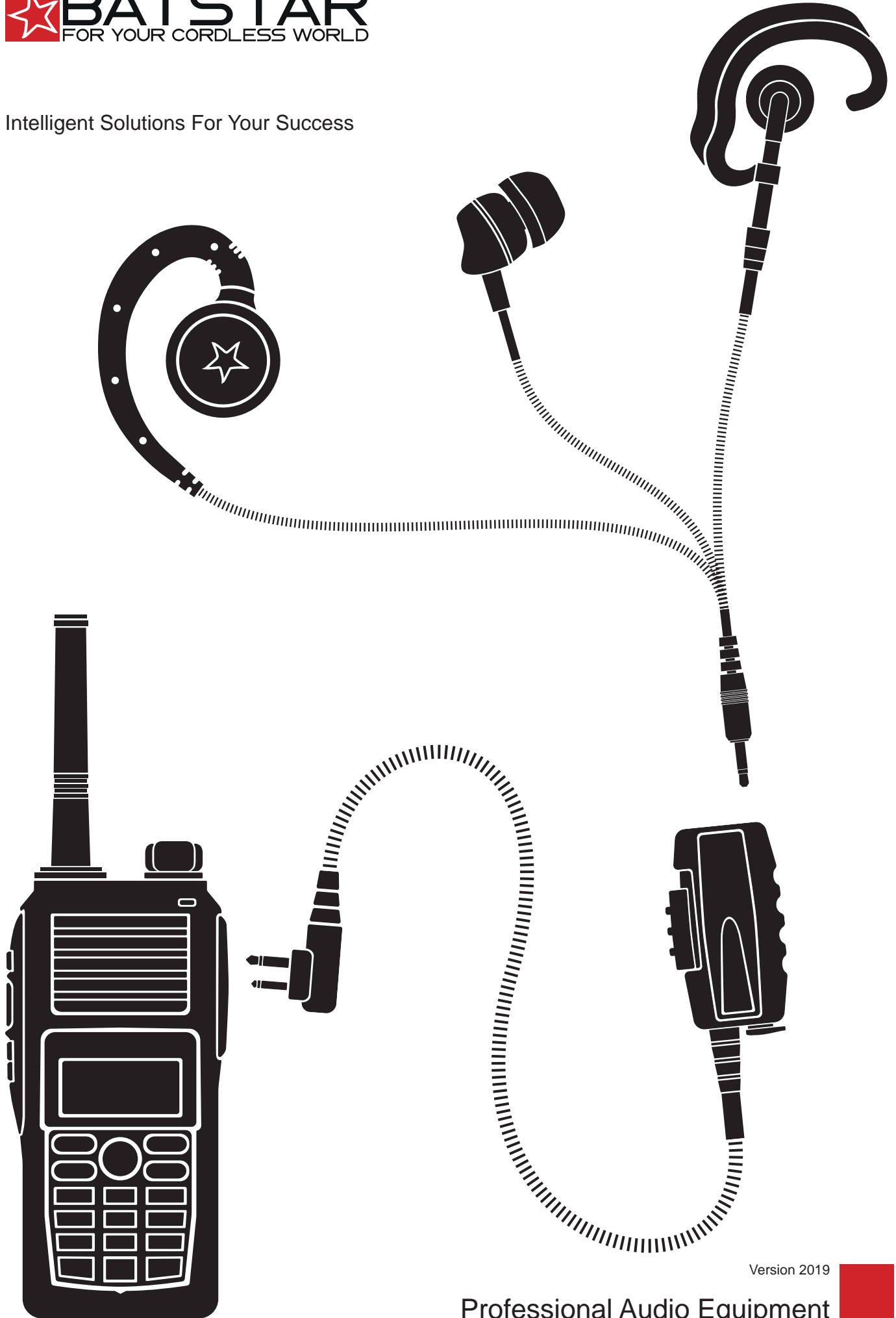

Choose BATSTAR!

BATSTAR is a German specialist for high performance battery packs, audio solutions and professional mobile radios. With sixteen years of experience in developing and manufacturing professional battery packs, charging devices and audio equipment, we can offer a great range of products in the field of communication.

Clever ideas and quality management are our main focus, to challenge the valuation of suitability. Our ongoing mission is to develop and optimize our products to the best-fit solution that meets the customer's needs. We are always looking for new opportunities to implement your ideas.

We have the ambition to produce, offer and deliver high quality products, just in time with a fair value, to meet the client requirements. Before delivering our products, the goods have to get through a detailed quality control to get the seal of BATSTAR guarantee.

With a first-class service, which is our qualified and motivated sales team, we serve customers all over the world. The BATSTAR-Team knows more than just a part number of the product you are looking for. If you have any specific question or you want to place an order, please contact us for individual expert advice.



Only Listening	
Simple Ear-Bud	04
Single Ear-Bud	04
Comfort Ear-Piece	04
Comfort Ear-Bud with Ear-Hook	04
Simple Ear-Bud with Ear-Hook	05
Ear-Hook Acoustic Tube	05
Ear-Bud Acoustic Tube	05
Ear-Bone Vibration Ear-Bud	05
Earphone Acoustic Tube Series	
Professional Audio Solution	06
Earphone Acoustic Tubes	07
Accessories & Spareparts	08
D-Shaped Earphone „Standard“	10
C-Shaped Earphone „Platin“	10
Swivel Ear-Hook	10
Dual-Pin Solution Series	11
Multi-Choice	12
Push-To-Talk PTTs	14
Wire Kits	16
Headsets	
Overhead Comfort-Headset	18
Spareparts	20
Easy Repair	21
Behind-The-Head Headset	22
D-Shape Headset	22
C-Shape Headset	23
Dual Earmuff Headsets	24
Flexible Audio Solutions	26
Headset Accessories	27
Bone Conduction Accessory	28
Dual Throat Microphones	29
Speaker Microphones	30
Bluetooth® Accessory	32
Audio Adapter	34
Audio Adapter for Motorola	34
Adapter HiRose 6-pole	34
Adapter HiRose 12-pole	35
Connectors	36

Simple Ear-Bud



part number		description
5 5120 00 1	2521	to 2.5 mm straight Standard Audio Connector 2-pole
5 5120 00 1	2522	to 2.5 mm right angle Standard Audio Connector 2-pole
5 5120 00 1	3521	to 3.5 mm straight Standard Audio Connector 2-pole
5 5120 00 1	3522	to 3.5 mm right angle Standard Audio Connector 2-pole

Single Ear-Bud



part number		description
5 5131 00 1	2521	to 2.5 mm straight Standard Audio Connector 2-pole
5 5131 00 1	2522	to 2.5 mm right angle Standard Audio Connector 2-pole
5 5131 00 1	3521	to 3.5 mm straight Standard Audio Connector 2-pole
5 5131 00 1	3522	to 3.5 mm right angle Standard Audio Connector 2-pole

Comfort Ear-Piece



part number		description
5 5151 00 1	2521	to 2.5 mm straight Standard Audio Connector 2-pole
5 5151 00 1	2522	to 2.5 mm right angle Standard Audio Connector 2-pole
5 5151 00 1	3521	to 3.5 mm straight Standard Audio Connector 2-pole
5 5151 00 1	3522	to 3.5 mm right angle Standard Audio Connector 2-pole

Comfort Ear-Bud with Ear-Hook



part number		description
5 5211 00 1	2521	to 2.5 mm straight Standard Audio Connector 2-pole
5 5211 00 1	2522	to 2.5 mm right angle Standard Audio Connector 2-pole
5 5211 00 1	3521	to 3.5 mm straight Standard Audio Connector 2-pole
5 5211 00 1	3522	to 3.5 mm right angle Standard Audio Connector 2-pole

Simple Ear-Bud with Ear-Hook



part number		description
5 5251 00 1	2521	to 2.5 mm straight Standard Audio Connector 2-pole
5 5251 00 1	2522	to 2.5 mm right angle Standard Audio Connector 2-pole
5 5251 00 1	3521	to 3.5 mm straight Standard Audio Connector 2-pole
5 5251 00 1	3522	to 3.5 mm right angle Standard Audio Connector 2-pole

Ear-Hook Acoustic Tube



part number		description
5 5261 00 1	2521	to 2.5 mm straight Standard Audio Connector 2-pole
5 5261 00 1	2522	to 2.5 mm right angle Standard Audio Connector 2-pole
5 5261 00 1	3521	to 3.5 mm straight Standard Audio Connector 2-pole
5 5261 00 1	3522	to 3.5 mm right angle Standard Audio Connector 2-pole

Ear-Bud Acoustic Tube



part number		description
5 5291 00 1	2521	to 2.5 mm straight Standard Audio Connector 2-pole
5 5291 00 1	2522	to 2.5 mm right angle Standard Audio Connector 2-pole
5 5291 00 1	3521	to 3.5 mm straight Standard Audio Connector 2-pole
5 5291 00 1	3522	to 3.5 mm right angle Standard Audio Connector 2-pole

Ear-Bone Vibration Ear-Bud inclusive 3 Ear-Buds of different sizes (S / M / L)



part number		description
5 5511 00 2	2521	to 2.5 mm straight Standard Audio Connector 2-pole
5 5511 00 2	2522	to 2.5 mm right angle Standard Audio Connector 2-pole
5 5511 00 2	3521	to 3.5 mm straight Standard Audio Connector 2-pole
5 5511 00 2	3522	to 3.5 mm right angle Standard Audio Connector 2-pole



Acoustic Tube - Professional Audio Solution

The Acoustic Tube is one of BATSTAR's most used audio solution worldwide. It is discreet, easy, extremely lightweight and provides a high wearing comfort.

Its transparent acoustic tube style fits every outfit and for a secured position it has a 240° revolving clip, which can be fixed at the user's clothing.

All parts of these Wire Kits are easy exchangeable and are available in different versions to meet the need of multiple users every day. Some articles of our product range are listed below.



- BATSTAR Acoustic Tube „30 Standard“
- discreet and easy
- changeable speaker
- „easy plug on tube“
- all parts exchangeable
- receives superior sound



- BATSTAR Acoustic Tube „35 Silver“
- discreet and easy
- „easy plug on tube“
- reinforced earphone clip
- industrial jacketed cable



- BATSTAR Acoustic Tube „39 Gold“
- discreet and easy
- changeable speaker
- „easy twist on tube“
- reinforced earphone clip
- industrial jacketed cable



- BATSTAR Acoustic Tube „40 Platin“
- discreet and easy
- changeable speaker
- „easy screw on tube“
- reinforced earphone clip
- industrial jacketed cable

Earphone Acoustic Tube „30 Standard“



part number		description
5 5301 00 1	2521	to 2.5 mm straight Standard Audio Connector 2-pole
5 5301 00 1	2522	to 2.5 mm right angle Standard Audio Connector 2-pole
5 5301 00 1	3521	to 3.5 mm straight Standard Audio Connector 2-pole
5 5301 00 1	3522	to 3.5 mm right angle Standard Audio Connector 2-pole
5 5301 00 1	3537	to 3.5 mm High Quality Standard Audio Thread Connector 3-pole

Earphone Acoustic Tube „35 Silver“



part number		description
5 5351 00 1	2521	to 2.5 mm straight Standard Audio Connector 2-pole
5 5351 00 1	2522	to 2.5 mm right angle Standard Audio Connector 2-pole
5 5351 00 1	3521	to 3.5 mm straight Standard Audio Connector 2-pole
5 5351 00 1	3522	to 3.5 mm right angle Standard Audio Connector 2-pole

Earphone Acoustic Tube „39 Gold“



part number		description
5 5391 00 1	2521	to 2.5 mm straight Standard Audio Connector 2-pole
5 5391 00 1	2522	to 2.5 mm right angle Standard Audio Connector 2-pole
5 5391 00 1	3521	to 3.5 mm straight Standard Audio Connector 2-pole
5 5391 00 1	3522	to 3.5 mm right angle Standard Audio Connector 2-pole

Earphone Acoustic Tube „40 Platin“



part number		description
5 5401 00 1	2521	to 2.5 mm straight Standard Audio Connector 2-pole
5 5401 00 1	2522	to 2.5 mm right angle Standard Audio Connector 2-pole
5 5401 00 1	3521	to 3.5 mm straight Standard Audio Connector 2-pole
5 5401 00 1	3522	to 3.5 mm right angle Standard Audio Connector 2-pole
5 5401 00 1	3537	to 3.5 mm High Quality Standard Audio Thread Connector 3-pole



Earphone Acoustic Tube Series

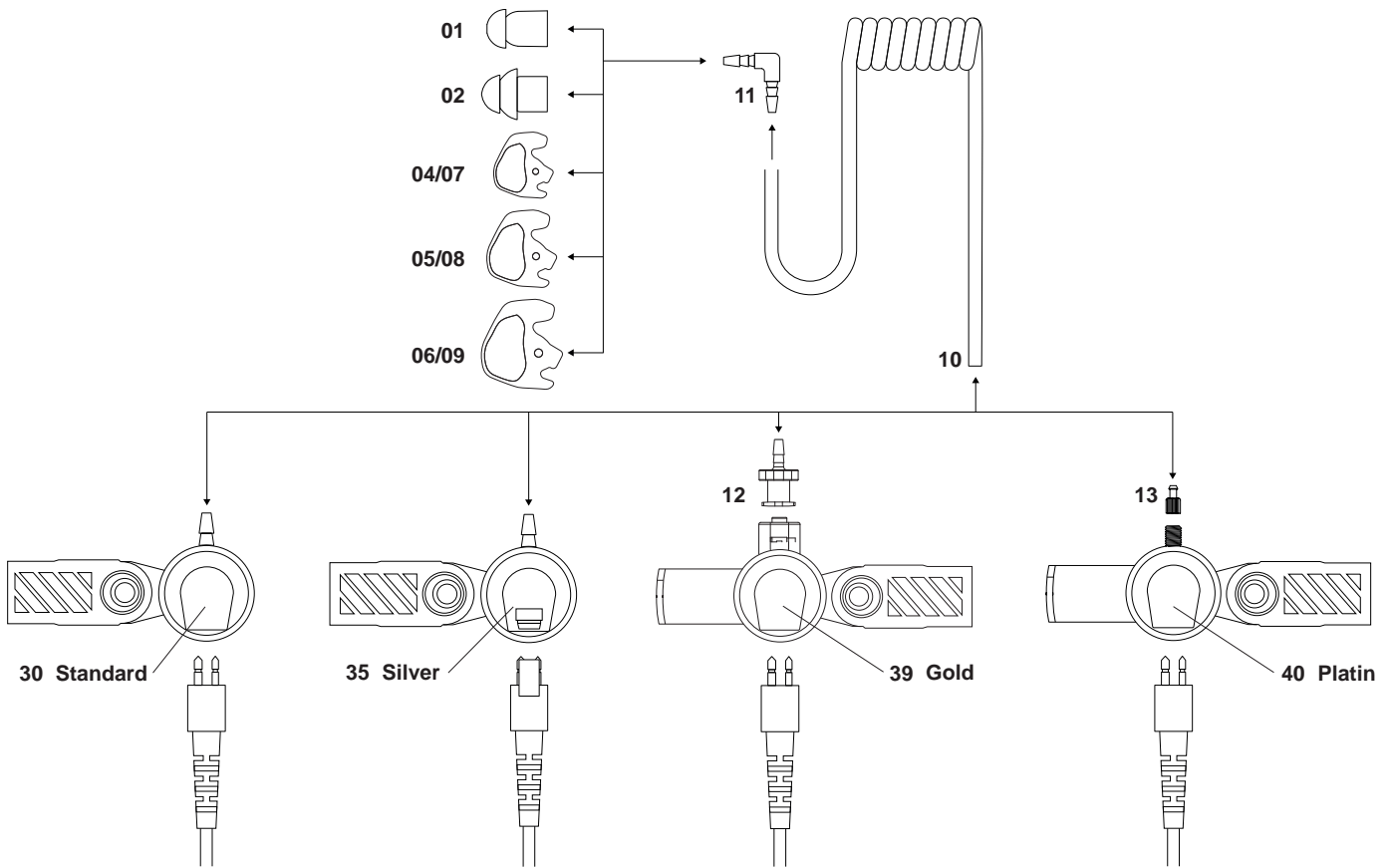

Accessories & Spareparts

ID	part number	description
	01 5 5300 00 9 0001	Ear-Bud for Acoustic Tube Series (Ear-Hook, Ear-Bud & Earphone) One Layer (Small) packing units: 10 / 100 / 1000 pieces
	02 5 5300 00 9 0002	Ear-Bud for Acoustic Tube Series (Ear-Hook, Ear-Bud & Earphone) Two Layer (Large) packing units: 10 / 100 pieces
	03 5 5300 00 9 0003	Set of 2 Ear-Buds for Acoustic Tube Series (Ear-Hook, Ear-Bud & Earphone) 1x Small / 1x Large packing units: (1/1) / (10/10) / (100/100) / (1000/1000) pieces
	04 5 5300 00 9 0011	Ear-Mold for Earphone Acoustic Tube Series (D = 21.1 mm) (Small / Right) packing units: 1 / 10 pieces
	05 5 5300 00 9 0012	Ear-Mold for Earphone Acoustic Tube Series (D = 23.9 mm) (Middle / Right) packing units: 1 / 10 pieces



ID	part number	description
06	5 5300 00 9 0013	Ear-Mold for Earphone Acoustic Tube Series (D = 26.3 mm) (Large / Right) packing units: 1 / 10 pieces



07	5 5300 00 9 0021	Ear-Mold for Earphone Acoustic Tube Series (D = 21.1 mm) (Small / Left) packing units: 1 / 10 pieces
----	------------------	--



08	5 5300 00 9 0022	Ear-Mold for Earphone Acoustic Tube Series (D = 23.9 mm) (Middle / Left) packing units: 1 / 10 pieces
----	------------------	---



09	5 5300 00 9 0023	Ear-Mold for Earphone Acoustic Tube Series (D = 26.3 mm) (Large / Left) packing units: 1 / 10 pieces
----	------------------	--



10	5 5300 00 9 0080	Transparent Acoustic Tube for Earphone Acoustic Tube Series packing unit: 10 pieces overpacking unit: 100 pieces
----	------------------	--



11	5 5300 00 9 0090	Connecting Piece 90 Degree for Earphone Acoustic Tube Series packing unit: 10 pieces overpacking unit: 100 pieces
----	------------------	---



12	5 5390 00 9 0070	Connecting Piece „Easy Twist“ for Earphone Acoustic Tube, Type: 39 Gold packing unit: 10 pieces
----	------------------	--



13	5 5400 00 9 0070	Connecting Piece „Easy Screw“ for Earphone Acoustic Tube, Type: 40 Platin packing unit: 10 pieces
----	------------------	--



30	5 5300 00 9 0060	Sound Transducer inclusive Clip for Earphone Acoustic Tube, Type: 30 Standard packing unit: 10 pieces overpacking unit: 100 pieces
----	------------------	--



35	5 5350 00 9 0060	Sound Transducer inclusive Clip for Earphone Acoustic Tube, Type: 35 Silver packing unit: 10 pieces overpacking unit: 100 pieces
----	------------------	--



39	5 5390 00 9 0060	Sound Transducer inclusive Clip for Earphone Acoustic Tube, Type: 39 Gold packing unit: 10 pieces overpacking unit: 100 pieces
----	------------------	--



40	5 5400 00 9 0060	Sound Transducer inclusive Clip for Earphone Acoustic Tube, Type: 40 Platin packing unit: 10 pieces overpacking unit: 100 pieces
----	------------------	--

D-Shaped Earphone „Standard“ - Flexible Ear-Loop

part number		description
5 5201 00 1	2521	to 2.5 mm straight Standard Audio Connector 2-pole
5 5201 00 1	2522	to 2.5 mm right angle Standard Audio Connector 2-pole
5 5201 00 1	3521	to 3.5 mm straight Standard Audio Connector 2-pole
5 5201 00 1	3522	to 3.5 mm right angle Standard Audio Connector 2-pole

C-Shaped Earphone „Platin“ - Ergonomic Ear-Loop (Flexible and Adjustable) inclusive Rotatable Cable Design

part number		description
5 5271 00 1	2521	to 2.5 mm straight Standard Audio Connector 2-pole
5 5271 00 1	2522	to 2.5 mm right angle Standard Audio Connector 2-pole
5 5271 00 1	3521	to 3.5 mm straight Standard Audio Connector 2-pole
5 5271 00 1	3522	to 3.5 mm right angle Standard Audio Connector 2-pole

BESTSELLER
Swivel Ear-Hook

- 90° rotatable ear-bud for a comfortable use on left or right ear
- Soft rubbered ear-hook fits the ear-form perfectly without slipping off
- Due to the flexible materials the ear-hook can be bent easily
- Its flexibility makes it suitable for a lot of ear sizes and forms
- The Swivel Ear-Hook is one of those headsets you won't give back - never!

part number		description
5 5221 00 1	2521	to 2.5 mm straight Standard Audio Connector 2-pole
5 5221 00 1	2522	to 2.5 mm right angle Standard Audio Connector 2-pole
5 5221 00 1	3521	to 3.5 mm straight Standard Audio Connector 2-pole
5 5221 00 1	3522	to 3.5 mm right angle Standard Audio Connector 2-pole

Dual-Pin Solution Series



Single Ear-Bud incl. 3 Ear-Buds
(5 5130 00 9 5309)
packing unit: 10 pieces



Dual Ear-Bud incl. Set of Ear-Buds
(5 5140 00 9 5309)
packing unit: 10 pieces



C-Shaped Earphone „Platin“
(5 5270 00 9 5309)
packing unit: 10 pieces



Ear-Bone Vibration Ear-Bud
(5 5510 00 9 5309)
packing unit: 10 pieces

Dual-Pin Jack



Dual-Pin Connector



Motorola MTP850



Kenwood TK-3401



Icom IC-F2000



XXXX

WHAT DO
YOU
NEED
?*

* Please see our *Overview of Connectors* starting on page 36.



→ Select Your Favorite Earphone!



→ Choose A PTT!







→ Tell Us Which Radio You Use!



Do you like to watch
a short video about this?



Multi-Choice Earphones

	part number	description
	5 5131 00 2 3521	Single Ear-Bud to 3.5 mm straight Standard Audio Connector 2-pole
	5 5211 00 2 3521	Comfort Ear-Bud with Ear-Hook to 3.5 mm straight Standard Audio Connector 2-pole
	5 5221 00 2 3521	Swivel Ear-Hook to 3.5 mm straight Standard Audio Connector 2-pole
	5 5271 00 2 3521	C-Shaped Earphone „Platin“ to 3.5 mm straight Standard Audio Connector 2-pole
	5 5351 00 2 3521	Earphone Acoustic Tube „Silver“ to 3.5 mm straight Standard Audio Connector 2-pole

Multi-Choice Push-To-Talk PTTs

PTT19



- 3.5 mm audio jack for optional earphone on top
- 360° revolving clip
- Inclusive microphone
- 2.5 mm mono socket for optional accessory at the bottom
- Covered end of clip for protecting clothes





































PTT38



- 3.5 mm audio jack for optional earphone at the bottom
- 360° revolving clip
- Inclusive microphone
- Large PTT button for more grip
- Dual switch technology for more reliability in the field



	part number	IP class	lapel PTT	inline PTT	tactical PTT	multi-use PTT	finger PTT	optional PTT	vox option	microphone	360° clip	front PTT	side PTT	3.5 mm jack	2.5 mm jack (PTT)	replaceable cable
	5 XXXX 12 X XXXX	54	x							x ¹	x	x				
	5 XXXX 14 X XXXX	54	x							x	x		x			
	5 XXXX 15 X XXXX	54		x						x	x		x			
	5 XXXX 16 X XXXX	54	x						x	x	x		x			
	5 XXXX 17 X XXXX	54		x					x	x	x		x		x	
	5 XXXX 18 X XXXX	54				x			x	x	x		x	x	x	
	5 XXXX 19 X XXXX	54				x				x	x		x	x	x	
	5 XXXX 20 X XXXX	54		x						x ¹	x	x				
	5 XXXX 21 X XXXX	54		x					x	x ¹	x	x				
	5 XXXX 23 X XXXX	56	x								x	x			x	
	5 XXXX 24 X XXXX	56	x						x		x	x			x	
	5 XXXX 26 X XXXX	54		x						x						
	5 XXXX 28 X XXXX	54	x							x	x		x			
	5 XXXX 30 X XXXX	56		x								x				
	5 XXXX 31 X XXXX	54					x	x		x	x		x			
	5 XXXX 33 X XXXX	54					x	x		x	x		x			
	5 XXXX 35 X XXXX	n/a	x							x	x	x				
	5 XXXX 38 X XXXX	54				x				x	x		x	x		

replaceable cable	2.5 mm jack (PTT)	3.5 mm jack	side PTT	front PTT	360° clip	microphone	vox option	optional PTT	finger PTT	multi-use PTT	tactical PTT	inline PTT	lapel PTT	IP class	part number	
			x		x	x						x		54	5 XXXX 41 X XXXX	
			x		x	x	x					x		54	5 XXXX 42 X XXXX	
	x		x		x							x		54	5 XXXX 46 X XXXX	
	x		x		x		x					x		54	5 XXXX 47 X XXXX	
				x	x	x							x	54	5 XXXX 49 X XXXX	
	x			x	x								x	54	5 XXXX 53 X XXXX	
				x	x	x							x	54	5 XXXX 54 X XXXX	
			x		x	x							x	54	5 XXXX 58 X XXXX	
			x		x	x	x						x	54	5 XXXX 59 X XXXX	
x				x	x						x			55	5 XXXX 61 X XXXX	
x				x	x						x			56	5 XXXX 62 X XXXX	
		x ²		x	x						x	x		67	5 XXXX 64 X XXXX	
x				x	x						x			67	5 XXXX 65 X XXXX	
x	x ³	x ³		x	x						x			67	5 XXXX 66 X XXXX	
				x				x	x					55	5 XXXX 81 X XXXX	
				x	x			x	x					55	5 XXXX 82 X XXXX	
				x				x	x					55	5 XXXX 84 X XXXX	
			x					x	x					54	5 XXXX 88 X XXXX	

¹ Possible to produce PTT with microphone element on request

² Jack for 3.5 mm headphone audio thread connector

³ Choose if you need an optional PTT to adapt or an earphone jack for your audio accessory



ONE WIRE KITS

Choose Your Favourite Earphone!

Pick the earphone you like out of BATSTAR's collection „Only Listening“, to start building your individual Wire Kit!

(Please see page 4, 5, 7 and 10.)



Comfort Ear-Bud with Ear-Hook



Single Ear-Bud



C-Shaped Earphone „Platin“

Need An Additional Microphone?

If you need a microphone, but the Push-To-Talk you choose doesn't have one (already), you have the choice between an Inline Microphone or a Lapel Microphone.



Inline Microphone



Inline Microphone

Which PTT Do You Prefer?

Tell us what you need!
Inline PTT, Finger PTT or Lapel PTT?
Is it a Tactical PTT you are looking for?
Choose a PTT out of our great collection of Push-To-Talk solutions!

(Please see page 14 and 15.)



Inline PTT15 (+ Microphone)



Inline PTT47

Tell Us, Which Radio You Use!

Are you using Motorola Radios?
Do you work with a PMR446 Solution?
Kenwood is your favourite manufacturer?
Pick the connector your solution needs!

(Please find our Connector's overview starting on page 36.)



TWO WIRE KITS

THREE WIRE KIT



Swivel Ear-Hook



Earphone Acoustic Tube
„39 Gold“



Simple Ear-Bud



D-Shaped Earphone
„Standard“



Earphone Acoustic Tube
„30 Standard“



Inline Microphone



Lapel
Microphone



Lapel
Microphone



Lapel
Microphone



Finger PTT31
(+ Microphone)



Finger PTT88



Tactical Inline
PTT64



Finger PTT84

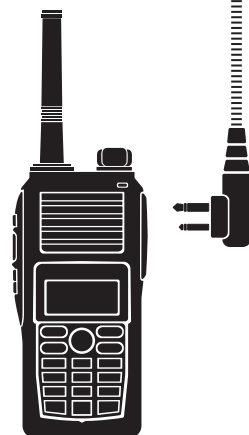
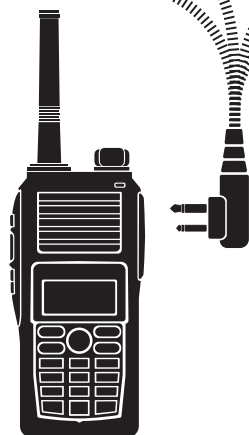



The Comfort-Headband is available in 2 sizes - S and L. It can be adjusted in 8 steps to provide a comfortable use for all users. The soft and flexible headband pads can be replaced for hygienic purposes.



A water protected, noise cancelling microphone element provides a clear audio and voice quality. It is suitable for frozen storage areas up to - 40°C.



The industrial jacketed cable and the internal strengthening at each end provide a safe use and a maximum lifetime in the field.



The microphone boom allows a 280° rotation for both - left and right hander - and can be adjust easily with one hand while wearing it.

Overhead Comfort-Headset - Size „S“

part number		description
5 8121 00 2	1045	to QD-Systemconnector (Quick Disconnect)
5 8121 00 2	1057	to Thread Connector 5-pole
5 8121 00 1	1061	to 6-pin HiRose-Systemconnector (16cm cable)
5 8121 00 1	2532	to 2.5 mm right angle High Quality Audio Connector 3-pole
5 8121 00 1	3532	to 3.5 mm right angle High Quality Audio Connector 3-pole
5 8121 00 1	3541	to 3.5 mm straight Premium Audio Connector 4-pole



Overhead Comfort-Headset - Size „L“

part number		description
5 8123 00 2	1045	to QD-Systemconnector (Quick Disconnect)
5 8123 00 2	1057	to Thread Connector 5-pole
5 8123 00 1	1061	to 6-pin HiRose-Systemconnector (16cm Cable)
5 8123 00 1	2532	to 2.5 mm right angle High Quality Audio Connector 3-pole
5 8123 00 1	3532	to 3.5 mm right angle High Quality Audio Connector 3-pole
5 8123 00 1	3541	to 3.5 mm straight Premium Audio Connector 4-pole





„You like Alternatives
but we like
Grand Solutions“

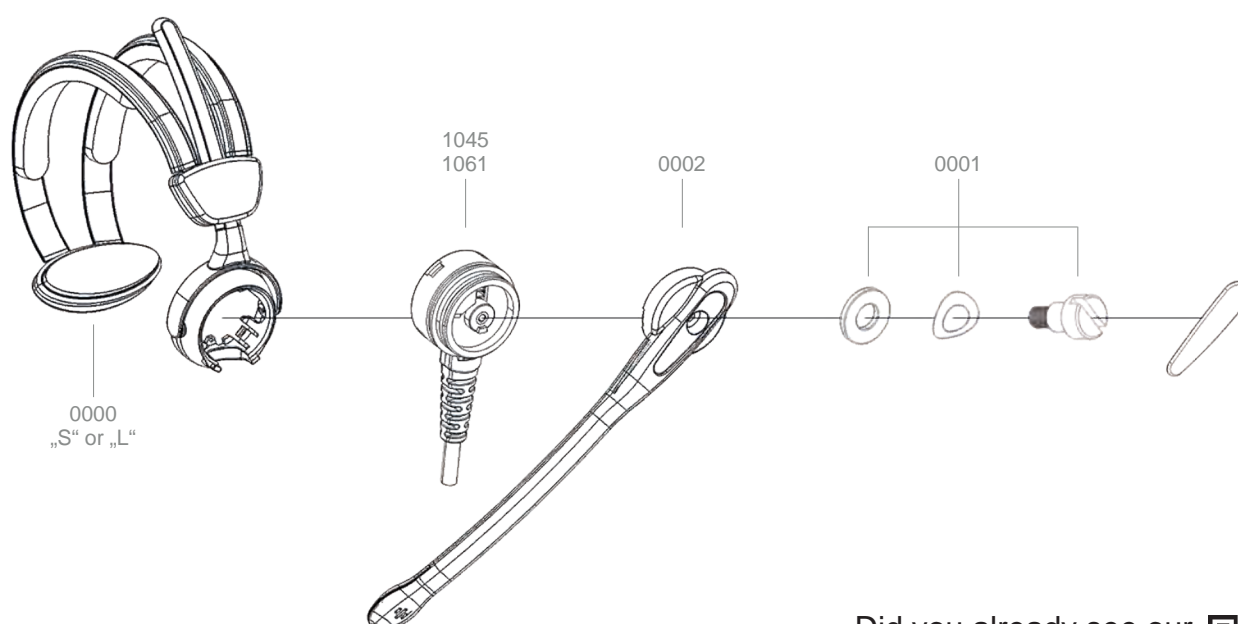

Spare Parts: Overhead Comfort-Headset

part number	description
5 8111 00 9 0001	Screw-Kit for Microphone Boom for Overhead Comfort-Headset
5 8120 00 9 0002	Microphone Boom for Overhead Comfort-Headset
5 8111 00 9 0000	Headband for Overhead Comfort-Headset (Standard Size „S“)
5 8113 00 9 0000	Headband for Overhead Comfort-Headset (Large Size „L“)
5 8110 00 9 1045	Speaker for Overhead Comfort-Headset, with cable to QD-Systemconnector (Quick Disconnect)
5 8110 00 9 1061	Speaker for Overhead Comfort-Headset, with cable to 6-pin HiRose-Systemconnector
5 8110 00 9 7108	Mounting Disk for Overhead Comfort-Headset



Did you already see our tutorial about repairing the Overhead Comfort-Headset? 

How To Replace Broken Parts Of The Overhead Comfort-Headset

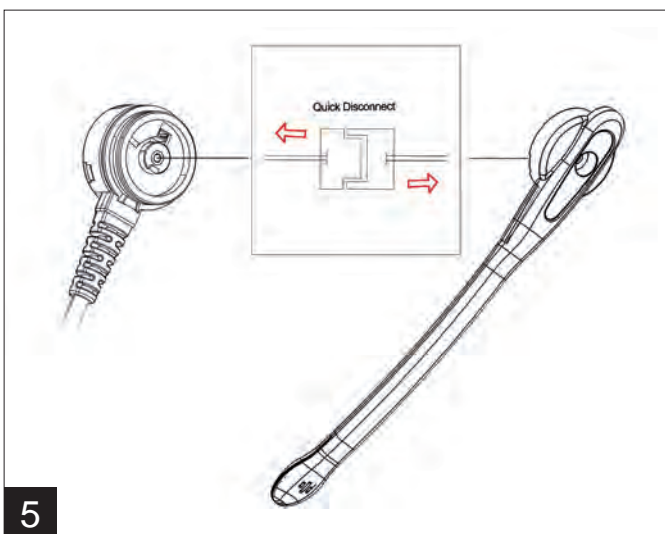
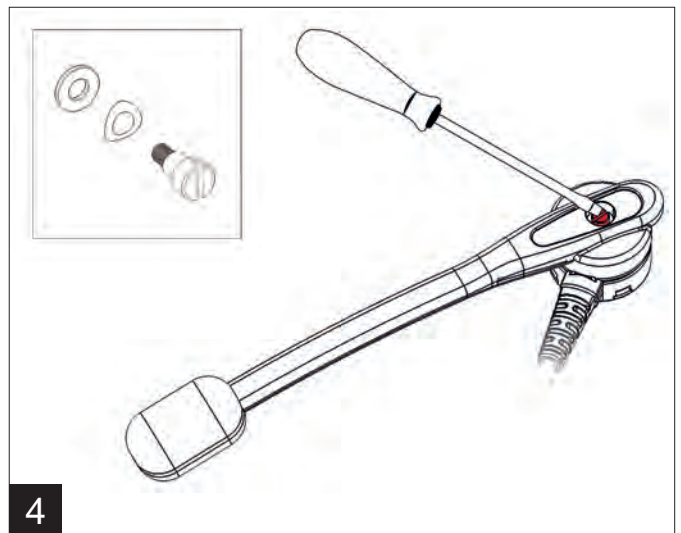
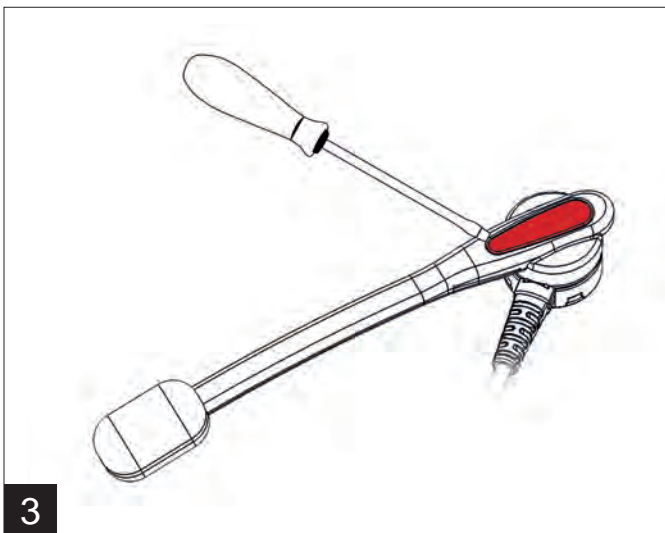
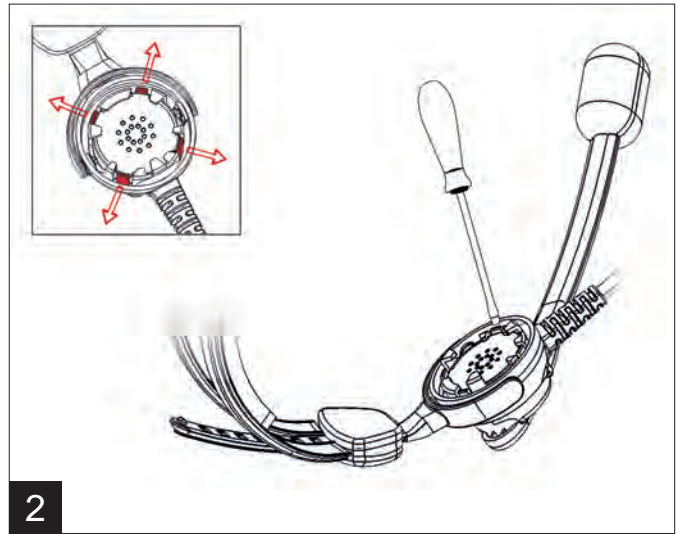
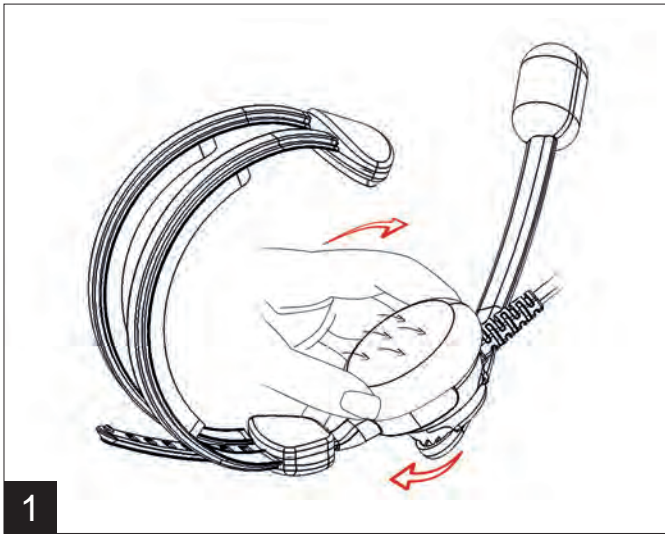

Behind-The-Head Headset



The Behind-The-Head Headset is designed really flat and lightweight - about 50 g - and provides a high wearing comfort. The headset has the IP-safety class 54 and can be used in frozen storage areas.



An adjustable headband (14 steps) makes the Behind-The-Head Headset suitable for multiple users in various environments. The headset is also comfortable together with a helmet!



The microphone boom can be adjusted very easily and has a water protected, noise cancelling microphone element, receiving superior audio quality.



D-Shape Headset



With only 20 g the D-Shape Headset is suitable for long time use due to its rubber ear loop which prevents slipping around the ear.



The gooseneck microphone boom can be bend and rotated to meet the users maximum comfort.



A high quality speaker element provides excellent transmitted sound for industrial or private communication.



C-Shape Headset



Adjustable ear-piece, made out of soft and flexible material suits users from small to large size ears, due to its C-shaped form. The large ear-pad provides even more comfort to the ears.



The water protected microphone element with professional noise cancelling function, is suitable for an operating temperature of - 40 to +80 °C and provides superior sound for an excellent communication.



An adjustable and flexible mic boom allows a 280° rotation for the use on the right or left ear, always keeping the user's most comfortable position.



The C-Shape Headset is exclusive designed for an easy handling in industrial environments. Due to the BATSTAR „Easy Repair“-System broken parts can easily and fast be replaced.



BATSTAR Earmuff Collection

All types of BATSTAR Dual Earmuff Headsets are easy to use due to the big control panel and the adjustable microphone boom.

With an IP safety class of IP56, the Earmuffs are suitable for any environment. The Dual Earmuff Behind-The-Head Headset is especially designed for the use with a helmet.

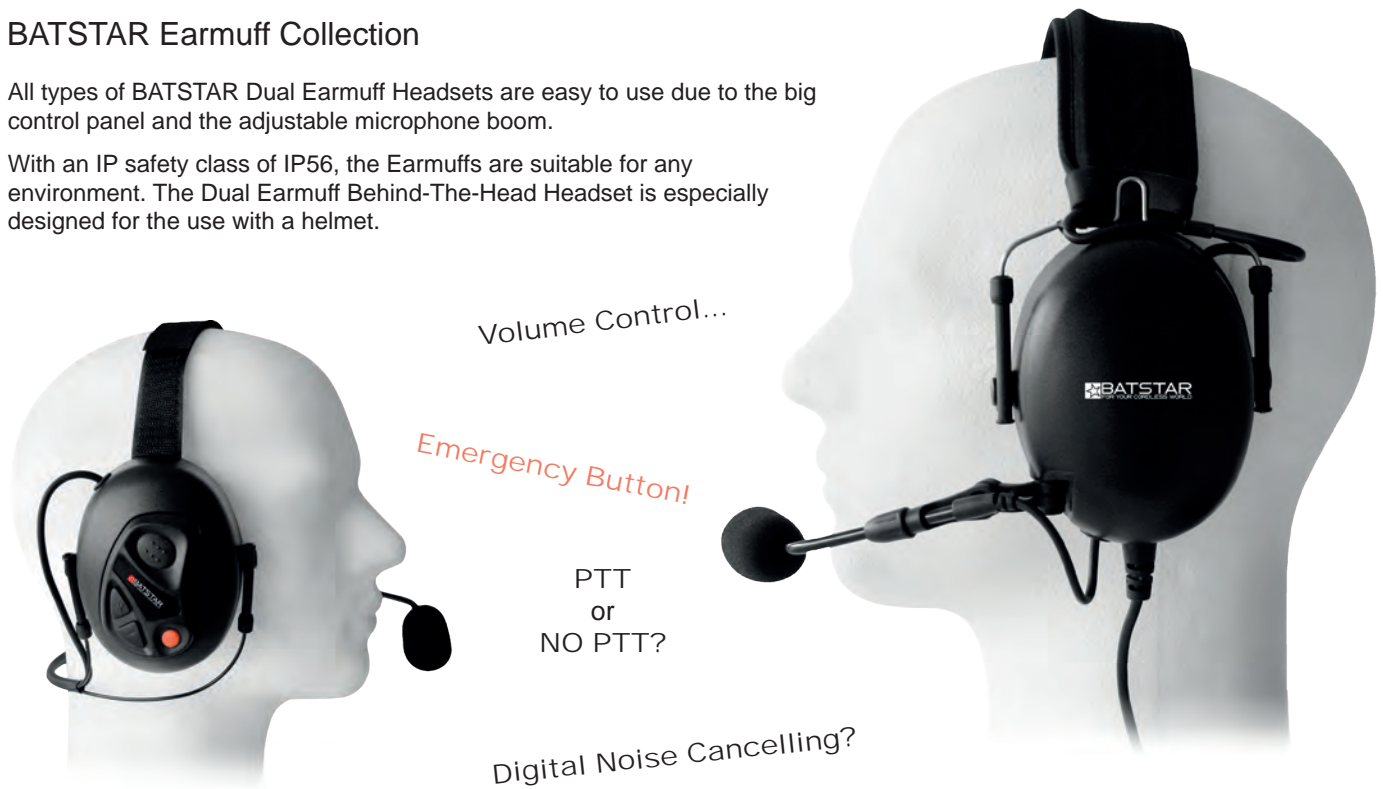





Dual Earmuff Headset

	part number	Noise Cancelling Microphone	Digital Noise Cancelling ¹	Push-To-Talk	Volume Control	Programmable Button ²
	5 8810 00 X XXXX	X				
	5 8820 01 X XXXX		X	X		
	5 8840 01 X XXXX	X		X	X	
	5 8850 01 X XXXX	X		X	X	X
	5 8870 01 X XXXX		X	X	X	X

¹Digital Noise Cancelling Microphone has an integrated digital signal processor to eliminate the noise waveform effectively.

²The programmable Button is preset as an Emergency Button as long as no other requirement is given.

Dual Earmuff Behind-The-Head Headset

	part number	Noise Cancelling Microphone	Digital Noise Cancelling ¹	Push-To-Talk	Volume Control	Programmable Button ²
	5 8910 00 X XXXX	X				
	5 8920 01 X XXXX		X	X		
	5 8950 01 X XXXX	X		X	X	X
	5 8970 01 X XXXX		X	X	X	X

¹Digital Noise Cancelling Microphone has an integrated digital signal processor to eliminate the noise waveform effectively.

²The programmable Button is preset as an Emergency Button as long as no other requirement is given.

Flex Earmuff Headset inclusive PTT & Noise Cancelling Microphone

Find the connector for your solution in our overview starting on page 36. Do you already know the Intercom system from Kenwood, the WD-Series? Why don't you use it with our Flex Headset and Adaptercable (5 6001 00 4 0204)?



WD-K10TR (Transceiver) WD-K10PBS (Portable Base)



part number	description	
5 8810 01 0 6009	to 5-pin Socket for Mini XLR Connector (5 XXXX XX X 6009)	

The Dual Earmuff Headset with the 5-pin socket for all Flex Headsets with mini XLR, provides individual flexibility combined with a wide range of adapter cables.



BATSTAR Headset Collection

In order to realize almost everything a customer could be interested in, we made it our business to keep our product portfolio as flexible as possible. Every company with all employees are individual factors, we have to consider. We make it easy for you to choose from a variety of components to create the perfect audio solution to meet your business needs.

- 1** PICK A HEADSET **2** SELECT A PUSH-TO-TALK **3** FIND THE RIGHT CONNECTOR

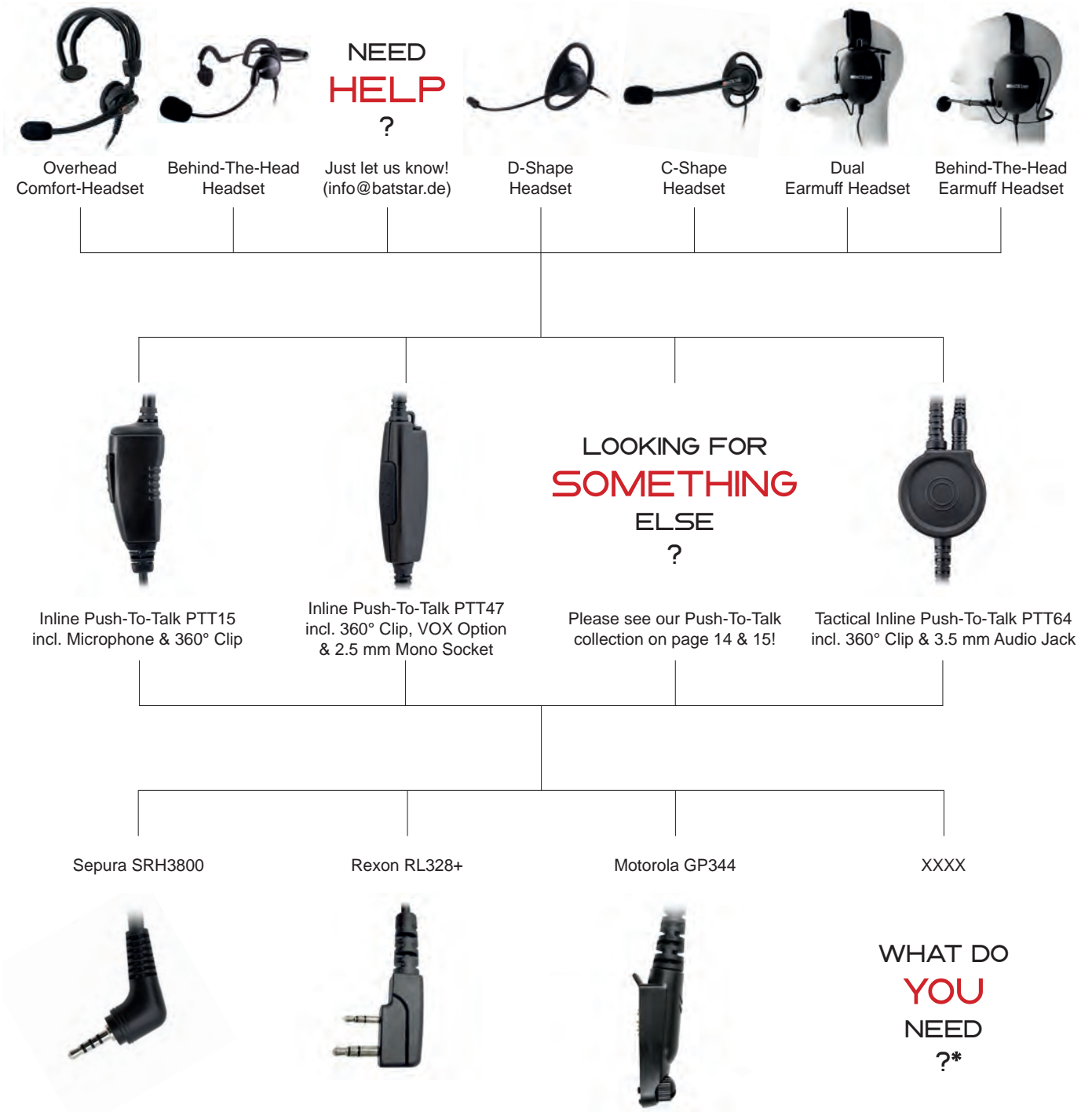

* Please see our *Overview of Connectors* starting on page 36.

Accessories

	part number	description
	5 2110 00 9 0001	Temple Pad (Fixing Pad) for Behind-The-Head Headset packing unit: 10 pieces overpacking unit: 100 pieces
	5 2110 00 9 0002	Ear Pad (Side of Speaker) for Behind-The-Head Headsets packing unit: 10 pieces overpacking unit: 100 pieces
	5 5120 00 9 0000	Ear Foam for Simple Ear-Bud & Comfort Ear-Bud Series packing unit: 10 pieces overpacking unit: 100 pieces
	5 6200 00 9 7103	Clip for Audiocable (Ø = 2 mm) for C-Shape Headset & D-Shape Headset packing unit: 10 pieces overpacking unit: 100 pieces
	5 8110 00 9 7101	Acoustic Microphone Foam Shield Waterproofed (Silicon-Teflon treated) for Overhead Comfort-Headset & Behind-The-Head Headset packing unit: 25 pieces overpacking unit: 250 pieces
	5 8110 00 9 7102	Acoustic Microphone Foam Shield (Standard) for Overhead Comfort-Headset & Behind-The-Head Headset packing unit: 25 pieces overpacking unit: 250 pieces
	5 8110 00 9 7103	Clip for Audiocable for Overhead Comfort- Headset & Behind-The-Head Headset packing unit: 10 pieces overpacking unit: 100 pieces
	5 8110 00 9 7106	Oval Foam Temple Pad (Fixing Pad) for Overhead Comfort-Headset packing unit: 10 pieces overpacking unit: 100 pieces
	5 8110 00 9 7107	Ear Pad (Side of Speaker) for Overhead Comfort-Headset packing unit: 25 pieces overpacking unit: 125 pieces
	5 8110 00 9 7108	Mounting Disk for Overhead Comfort-Headset packing unit: 10 pieces overpacking unit: 100 pieces
	5 8110 00 9 7109	Headband Pad for Overhead Comfort-Headset packing unit: 10 pieces overpacking unit: 100 pieces



Ear-Bone Microphone



part number	description
5 2010 00 X XXXX	<ul style="list-style-type: none"> • Speaking supported with ear-bone vibration • 2-in-1 small speaker and microphone module • Due to its ergonomic design it fits perfectly into the ear without slipping out • The flexible ear-hook guarantees additional stabilization • Anti-noise technology and no wind interference caused by the in-ear position

Bone Conduction Behind-The-Head Headset



part number	description
5 2150 00 X XXXX	<ul style="list-style-type: none"> • Speaking and listening through bone conduction technology • Noise cancelling microphone • Due to the Behind-The-Head design it can be worn with a helmet • The light weight design and the soft materials make it comfortable over a long time • While wearing both ears are completely free

Bone Conduction Skull Microphone



part number	description
5 2201 00 X XXXX	<ul style="list-style-type: none"> • Easy-To-Mount system for a comfortable use with helmets and respirator masks • Noise cancelling due to the bone conduction microphone element • Perfect audio quality, no wind interference, no noise from environment
5 2203 00 X XXXX	<ul style="list-style-type: none"> • While wearing both hands are completely free • Two sizes available: S (17 cm length) & XL (from 20 cm to 26 cm length adjustable)

Spare Parts: Bone Conduction Skull Microphone

part number	description
5 2200 00 9 0001	Standard Universal Fastening Strap, Type A
5 2200 00 9 0002	Universal Fastening Strap, Type B
5 2200 00 9 0003	Adapter-Set for MSA Auer Gallet Helmet

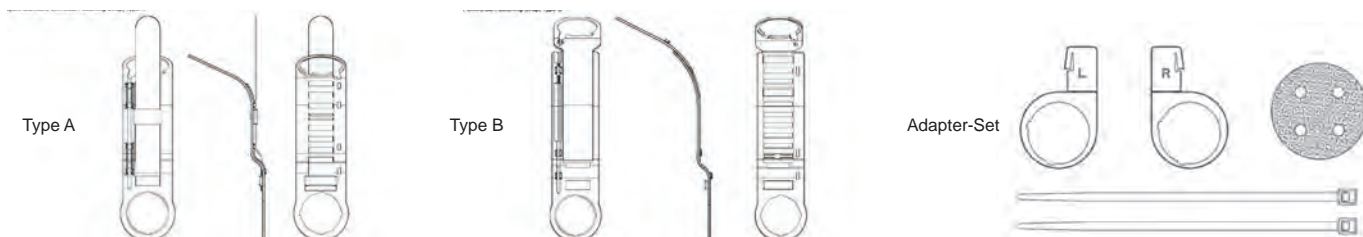

Dual Throat Microphone

inclusive Earphone Acoustic Tube



- Throat microphone provides highest audio transmission
- The microphone filters noises from the environment
- Adjustable neck ring for a comfortable use over a long time
- Transparent acoustic tube provides discreet communication
- Very hygienic due to the easy changeable acoustic tube

Dual Throat Microphone

inclusive D-Shaped Earphone „Silver“



- Throat microphone provides highest audio transmission
- The microphone filters noises from the environment
- Adjustable neck ring for multiple users
- D-Shaped speaker element for high quality audio output
- Light weight design of earphone for a long term use



Tactical Push-To-Talk PTT61

- Safety class IP55
- 360° clip
- Front PTT button
- Easy replaceable cable



Tactical Push-To-Talk PTT62

- Safety class IP56
- 360° clip
- Large front PTT button
- Easy replaceable cable



Tactical Push-To-Talk PTT64

- Safety class IP67
- 360° clip
- Large front PTT button
- 3.5 mm jack with thread
- Tactical inline PTT button



Tactical Push-To-Talk PTT65 / 66

- Safety class IP67
- 360° clip
- Large front PTT button
- Easy replaceable cable
- 2.5 mm / 3.5 mm jack

E-TECH EP-400



HYT / Hytera PD4 Series



Kenwood NX-5200E



XXXX

WHAT DO
YOU
NEED
?*

* Please see our *Overview of Connectors* starting on page 36.



[...] Speaker Microphone	part number	IP class	front PTT	side PTT	360° clip	audio jack	vox option	replaceable cable	emergency button	LED indicator	volume control	Nexus jack	noise cancelling (DSP)	noise cancelling	reflective board	megaphone function	mute function	strobe light	flash light
 Mini Remote	5 1000 XX X XXXX	55		x	x	x													
	5 1090 XX X XXXX	55		x	x	x	x												
 Light-Weight	5 2000 XX X XXXX	55		x	x	x													
 Comfort	5 3000 XX X XXXX	56		x	x	x		x											



Comfort Speaker Microphone



A 3.5 mm earphone jack offers the possibility to adapt an external earphone when needed.



The waterproof adapter connects speaker microphone and cable and offers a great flexible solution for repairing. All cables are industrial jacketed for a safe use and a maximum lifetime.





The rubber sealed housing and the ergonomic form of the speaker microphone offer a better grip and a safe use in wet environments. Condenser-style microphone element and a powerful speaker provides excellent transmitted audio clarity.



Multi-Function Speaker Microphone (IP68)



[...] Speaker Microphone	part number	IP class	front PTT	side PTT	360° clip	audio jack	vox option	replaceable cable	emergency button	LED indicator	volume control	Nexus jack	noise cancelling (DSP)	noise cancelling	reflective board	megaphone function	mute function	strobe light	flash light
	5 6060 XX X XXXX	68	x	x	x	x			x	x	x	x		x	x				
	5 6070 XX X XXXX	68	x	x	x	x			x	x	x	x		x	x	x			
	5 6560 XX X XXXX	68	x	x	x	x	x		x	x	x	x	x				x	x	x
	5 6560 XX X XXXX	68	x	x	x	x	x		x	x	x	x	x			x	x	x	x
	5 4000 XX X XXXX	68		x	x	x													
	5 4020 XX X XXXX	68		x	x	x			x										
	5 4030 XX X XXXX	68		x	x	x					x								
	5 4040 XX X XXXX	68		x	x	x			x		x								



Successfully Connected!

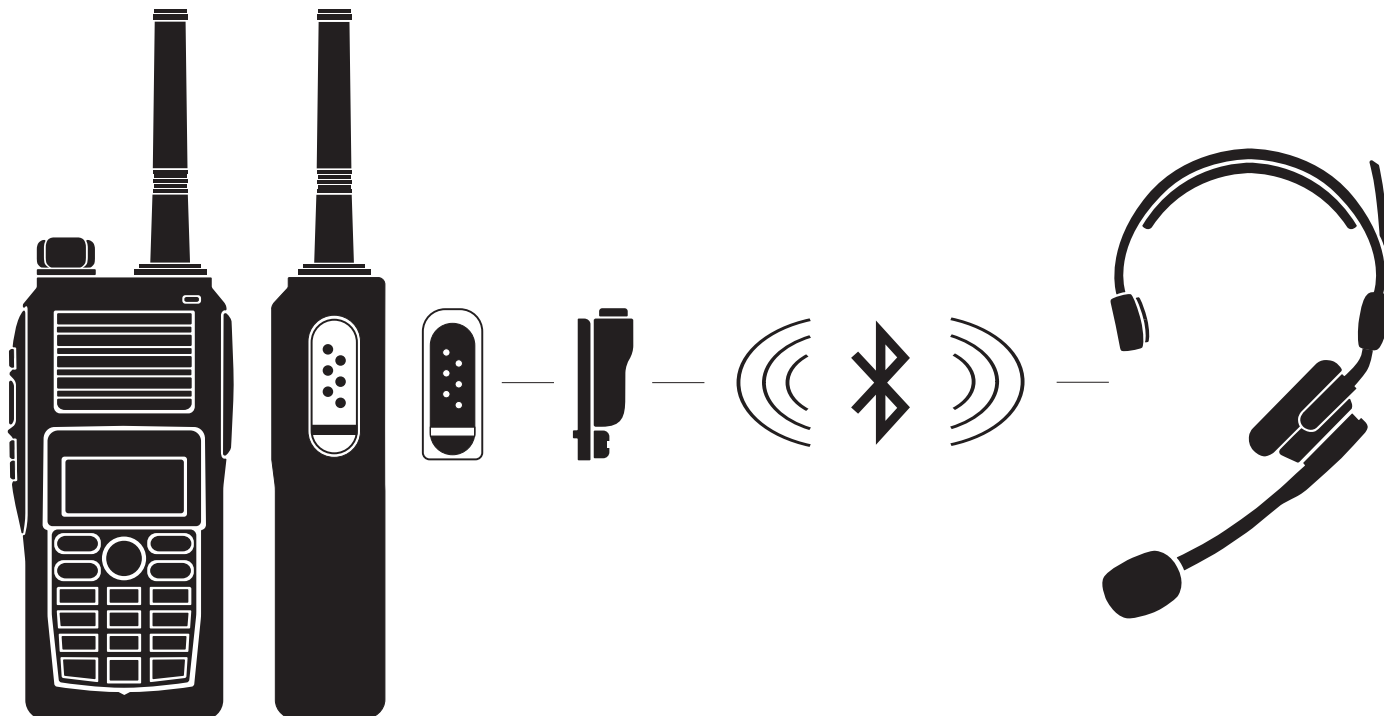

Wireless Adapter



part number

for device

5 0001 00 3 0104

GP140 / GP240 / GP280 / GP320 / GP328 / GP329 / GP330 / GP338 / GP339 / GP340 / GP350 / GP360 (FuG11b) / GP380 (FuG11b ATEX) / GP385 (FuG10b) / GP386 / GP540 / GP580 / GP600 / GP620 / GP640 / GP650 / GP660 / GP680 / GP760 / GP960 / GP1280 / HT750 / HT1250LS / HT1550XLS / MTP700 / MTP810EX / MTX850LS / MTX900 / MTX950 / MTX960 / MTX1500 / MTX8250LS / MTX9250 / PR860 / PRO5000 Series / PRO7000 Series / PRO9150 / PTX700 / PTX760 / PTX780 / R765 / Waris Series



5 0001 00 3 0110

APX1000 / APX2000 / APX3000 / APX4000 / APE6000 / APX7000 / APX7500 / APX8000 / DGP4150Plus / DGP5050 / DGP5550 / DGP6150Plus / DGP8050 / DGP8550 / DP3400 / DP3600 / DP4150 / DP4400 / DP4600 / DP4800 / DP6150 / MTP830FuG / MTP830S / MTP850 / MTP6550 / MTP6750 / SRX2200 / XiR8200 / XiR P8600 / XPR4500 / XPR6000 / XPR6100 / XPR6300 / XPR6500 / XPR7000



5 0001 00 3 0114

MOTOTRBO DEP550 / DEP570 / DP2000(e) Series (DP2400(e) / DP2600(e)) / DP3441 / MTP3000 / MTP3100 / MTP3150 / MTP3200 / MTP3250 / MTP3500 / MTP3550 / XiR P6600 / XiR P6608 / XiR P6620 / XiR P6628 / XPR3000 / XPR3300 / XPR3500

Wireless Earphone Connection Kit



part number

description

5 0001 00 3 0188

Large PTT, LED Indicator, 10m Connection Distance, Audio Jack¹ and Micro-USB Port for Charging

¹Compatible with BATSTAR Audio Equipment with Connector 0112 and Motorola Accessories for NNTN8191 wireless PTT

Wireless Dongle



part number	description
5 0001 00 4 XXXX	Looking for a dongle that makes your device wireless? Please see our <i>Overview of Connectors</i> starting on page 36 and tell us which connector you need! The dongle also is compatible with our Wireless Earphone Connection Kit.

Wireless Multi-Function Speaker Microphone



part number	description
5 6500 00 0 0001	Side and Tactical Front PTT, 360° Clip, 7.1 mm Nexus Jack 4-pole, LED Indicator, Volume Control incl. Mute Function, Red Strobe Light and Flash Light inclusive Mini USB-Port for Charging

Wireless Dual Earmuff Headset



part number	description
5 8850 01 0 0001	with Noise Canceling Microphone, PTT, LED Indicator, Volume Control and Adjustable Microphone Boom inclusive Mini USB-Port for Charging

Wireless Dual Behind-The-Head Earmuff



part number	description
5 8950 01 0 0001	with Noise Canceling Microphone, PTT, LED Indicator, Volume Control and Adjustable Microphone Boom inclusive Mini USB-Port for Charging

Wireless Tactical Earmuff Headset



part number	description
5 3560 01 0 0001	with Noise Canceling Microphone, PTT, LED Indicator, Volume Control, ON/OFF/Pairing Button, Adjustable Microphone Boom and Active Hearing Protection inclusive Mini USB-Port for Charging



Take it easy - Don't Throw Away Your Favourite Headset!

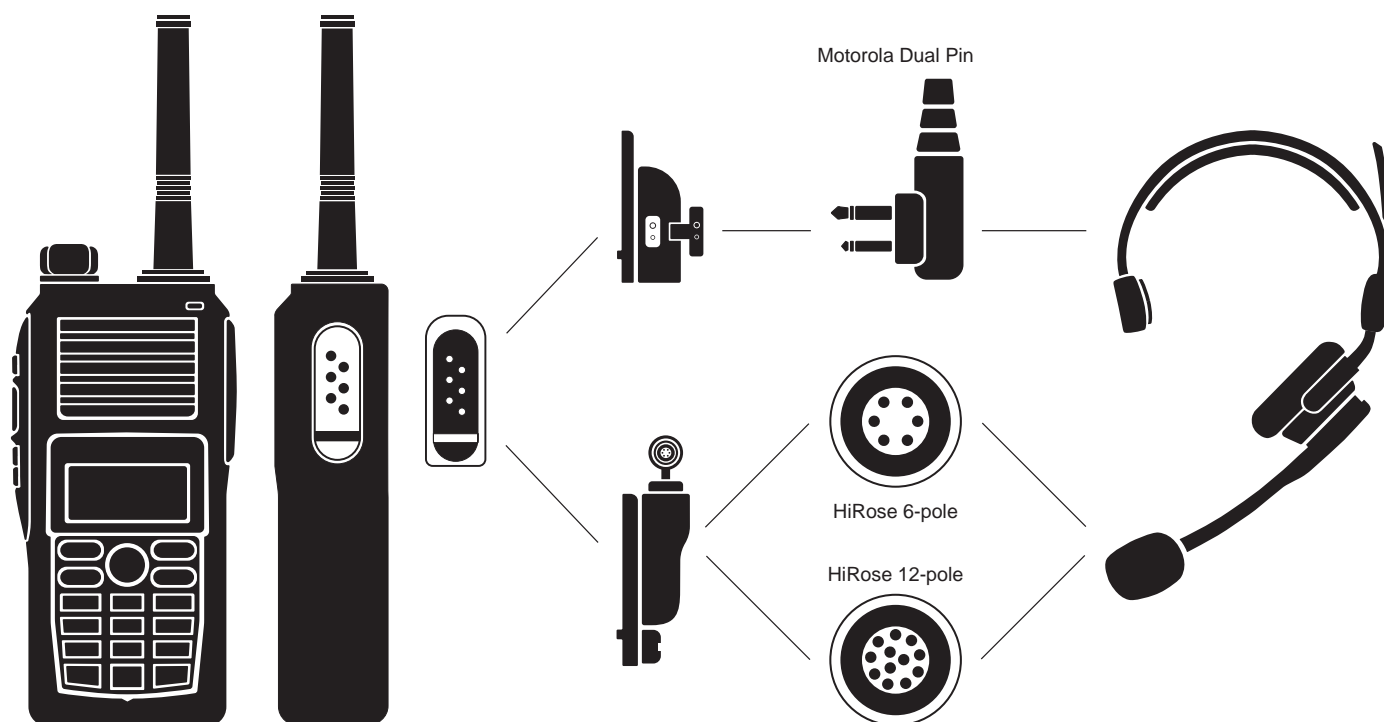

Audio Adapter for Motorola Standard Dual Pin Connector (0101) to Motorola



part number	for devices
5 0101 00 3 0104	GP140 / GP240 / GP280 / GP320 / GP328 / GP329 / GP330 / GP338 / GP339 / GP340 / GP350 / GP360 (FuG11b) / GP380 (FuG11b ATEX) / GP385 (FuG10b) / GP386 / GP540 / GP580 / GP600 / GP620 / GP640 / GP650 / GP660 / GP680 / GP760 / GP960 / GP1280 / HT750 / HT1250LS / HT1550XLS / MTP700 / MTP810EX / MTX850LS / MTX900 / MTX950 / MTX960 / MTX1500 / MTX8250LS / MTX9250 / PR860 / PRO5000 Series / PRO7000 Series / PRO9150 / PTX700 / PTX760 / PTX780 / R765 / Waris Series
5 0101 00 3 0105	EX500 / EX560XLS / EX600 / GL2000 / GP328Plus / GP338Plus / GP344 / GP388 / GP644 / GP688 / PRO5150 Elite / PTX760Plus
5 0101 00 3 0110	APX1000 / APX2000 / APX3000 / APX4000 / APE6000 / APX7000 / APX7500 / APX8000 / DGP4150Plus / DGP5050 / DGP5550 / DGP6150Plus / DGP8050 / DGP8550 / DP3400 / DP3600 / DP4150 / DP4400 / DP4600 / DP4800 / DP6150 / MTP830FuG / MTP830S / MTP850 / MTP6550 / MTP6750 / SRX2200 / XiR8200 / XiR P8600 / XPR4500 / XPR6000 / XPR6100 / XPR6300 / XPR6500 / XPR7000
5 0101 00 3 0114	MOTOTRBO DEP550 / DEP570 / DP2000(e) Series (DP2400(e) / DP2600(e)) / DP3441 / MTP3000 / MTP3100 / MTP3150 / MTP3200 / MTP3250 / MTP3500 / MTP3550 / XiR P6600 / XiR P6608 / XiR P6620 / XiR P6628 / XPR3000 / XPR3300 / XPR3500

Adapter HiRose 6-pole for Icom



part number	for device
5 1069 00 3 0912	IC-F3G / IC-F11 / IC-F33 / IC-T3H / IC-V8
5 1069 00 3 0913	IC-F31W / IC-41W / IC-F1000 / IC-F1000D / IC-F2000 / IC-F2000D / IC-F3031S / IC-F3032S / IC-F3033S / IC-F3036S / IC-F3230D / IC-F4031S / IC-F4032S / IC-F4033S / IC-F4036S / IC-F4230D / IC-V88

Adapter HiRose 6-pole for HYT / Hytera



part number	for device
5 1069 00 3 0802	BD502 / HYT2100 / PD400 Series / PD500 Series / POWER446 / TC-446S / TC-500 / TC-600 / TC-610 / TC-620 / TC-700EX / TC-1600 / TC-2100 / TR200 / TR400 / Titan
5 1069 00 3 0804	PD6-Series (PD605(G) / PD665(G) / PD685(G)) / PD602(G) / PD662(G) / PD682(G) / X1-Series (X1e / X1p / Z1p)

Adapter HiRose 6-pole for Kenwood



part number	for device
5 1069 00 3 0202	NX-200 / NX-210 / NX-230EX / NX-300 / NX-330EX / NX-410K / NX-411 / NX-420 / NX-3200 / NX-3220 / NX-3300 / NX-3320 / NX-5200E / NX-5300E / NX-5400 / P25 / TK-190 / TK-280 / TK-290 (FuG11b) / TK-380 / TK-385 / TK-390 / TK-480 / TK-2140 / TK-2180 / TK-2185E / TK-2260EX ATEX / TK-3140 / TK-3148 / TK-3180 / TK-D200 / TK-D240E / TK-D300E / TK-D340E / TK-5210 / TK-5220 / TK-5300 / TK-5310 / TK-5400 / TK-5410

Adapter HiRose 6-pole for Motorola



part number	for device
5 1069 00 3 0103	GP900 (FuG11b) / GP1200 / GP9000 / HT1000 / HT2000 / JT1000 / MOF230 / MT1000 / MT2000 / MT6000 / MTC900 / MTP200 / MTP300 / MTS1000 / MTS2000 / MTX838 / MTX868 / MTX900 / MTX960 / MTX1000 / MTX2000 / MTX8000 / MTX9000 / MTX-B5 / MTX-B7 / MTX-LS / PR1500 / PTX1200 / PTX3600 / XTS1500 / XTS2000 / XTS3000 / XTS3500 / XTS4250 / XTS5000 / XTS5000R / XTS5100 / XTS7700



5 1069 00 3 0104	GP140 / GP240 / GP280 / GP320 / GP330 / GP340 / GP350 / GP360 (FuG11b) / GP380 / GP385 (FuG10b) / GP386 / GP540 / GP580 / GP600 / GP760 / GP960 / GP1280 / HT750 / HT1250 / HT1550 / MTP700 / MTP810 / MTX850 / MTX900 / MTX1500 / MTX8250 / MTX9250 / PR860 / PRO5000 / PRO7000 / PRO9150 / PTX700 / R765 / Waris Series
5 1069 00 3 0105	EX500 / EX560XLS / EX600 / GL2000 / GP328Plus / GP338Plus / GP344 / GP388 / GP644 / GP688 / PRO5150 Elite / PTX760Plus
5 1069 00 3 0110	APX1000 / APX2000 / APX3000 / APX4000 / APE6000 / APX7000 / APX7500 / APX8000 / DGP4150Plus / DGP5050 / DGP5550 / DGP6150Plus / DGP8050 / DGP8550 / DP3400 / DP3600 / DP4150 / DP4400 / DP4600 / DP4800 / DP6150 / MTP830FuG / MTP830S / MTP850 / MTP6550 / MTP6750 / SRX2200 / XiR8200 / XiR P8600 / XPR4500 / XPR6000 / XPR6100 / XPR6300 / XPR6500 / XPR7000
5 1069 00 3 0113	SL1K / SL300 / SL1600 / SL2600 / SL4000 / SL4010 / SL7550 / SL7550e / SL7580e / SL7590 / SL7590e
5 1069 00 3 0114	MOTOTRBO DEP550 / DEP570 / DP2000(e) Series (DP2400(e) / DP2600(e)) / DP3441 / MTP3000 / MTP3100 / MTP3150 / MTP3200 / MTP3250 / MTP3500 / MTP3550 / XiR P6600 / XiR P6608 / XiR P6620 / XiR P6628 / XPR3000 / XPR3300 / XPR3500





Adapter HiRose 12-pole for Motorola







part number	for device
5 1129 00 3 0104	GP140 / GP240 / GP280 / GP320 / GP330 / GP340 / GP350 / GP360 (FuG11b) / GP380 / GP385 (FuG10b) / GP386 / GP540 / GP580 / GP600 / GP760 / GP960 / GP1280 / HT750 / HT1250 / HT1550 / MTP700 / MTP810 / MTX850 / MTX900 / MTX1500 / MTX8250 / MTX9250 / PR860 / PRO5000 / PRO7000 / PRO9150 / PTX700 / R765 / Waris Series
5 1129 00 3 0110	APX1000 / APX2000 / APX3000 / APX4000 / APE6000 / APX7000 / APX7500 / APX8000 / DGP4150Plus / DGP5050 / DGP5550 / DGP6150Plus / DGP8050 / DGP8550 / DP3400 / DP3600 / DP4150 / DP4400 / DP4600 / DP4800 / DP6150 / MTP830FuG / MTP830S / MTP850 / MTP6550 / MTP6750 / SRX2200 / XiR8200 / XiR P8600 / XPR4500 / XPR6000 / XPR6100 / XPR6300 / XPR6500 / XPR7000





Standard Audio Connector

	part number	description
	2521	to 2.5 mm straight Standard Audio Connector 2-pole
	2522	to 2.5 mm right angle Standard Audio Connector 2-pole
	3521	to 3.5 mm straight Standard Audio Connector 2-pole
	3522	to 3.5 mm right angle Standard Audio Connector 2-pole





High Quality Audio Connector

	part number	description
	2531	to 2.5 mm straight High Quality Audio Connector 3-pole
	2532	to 2.5 mm right angle High Quality Audio Connector 3-pole
	3531	to 3.5 mm straight High Quality Audio Connector 3-pole
	3532	to 3.5 mm right angle High Quality Audio Connector 3-pole
	3537	to 3.5 mm High Quality Audio Thread Connector 3-pole

Premium Audio Connector







	part number	description
	3541	to 3.5 mm straight Premium Audio Connector 4-pole
	3542	to 3.5 mm right angle Premium Audio Connector 4-pole

Connector and Socket for Nexus



	part number	description
	7141 ¹	to 7.3 mm straight Nexus Audio Connector 4-pole
	7149	to 7.1 mm Nexus Audio Jack 4-pole
	7151 ¹	to 7.3 mm straight Nexus Audio Connector 5-pole
	7159	to 7.1 mm Nexus Audio Jack 5-pole

¹Looking for Savox or Peltor? Please see page 44 for your information

Connector for AEG / Cassidian / EADS / Siemens

	part number	for device
	3102	(G2) Smart and Easy+ (Matra Tetrapol) P2G
	3103	TPH700 (G3) JUPITER (SR 45°)
	3113	Systemconnector (SR ,up' +90°) for TPH700 (G3) JUPITER
	3123	Systemconnector (SR ,down' -90°) for TPH700 (G3) JUPITER
	3104	TPH900 (G4)
	3194	FuG11b

Connector for Apple

	part number	for device
	4101 ¹	iPhone 2G / iPhone 3G / iPhone 3GS / iPhone 4 / iPhone 4S / iPhone 5 / iPhone 6 / iPad / iPod
	4102 ¹	iPhone 2G / iPhone 3G / iPhone 3GS / iPhone 4 / iPhone 4S / iPhone 5 / iPhone 6 / iPad / iPod

¹also compatible with HTC ONE / Sony Xperia Ion



Connector for Aselsan

	part number	for device
	3003 ¹	Aselsan Radio Series
¹ Interested in this product? Please contact us for more information.		



Connector for Bosch

	part number	for device
	2102	FuG10 / FuG10a(R) / FuG13a / HFE85 / HFE165 / HFE455 / HFG85 / HFG89 / HFG165 (FuG11b) / HFG455 / HFG459



Connector for Datron

	part number	for device
	1425 ¹	Guardian G25RPV100
¹ Interested in this product? Please contact us for more information.		

Connector for E-TECH

	part number	for device
	1503	IP-30 / IP-60 / IP-100 / IP-200
	1504	EP-400



Connector for Entel

	part number	for device
	1601	HX-446E
	1602	HX-400









Connector for GCD Plettac / Grundig

	part number	for device
	0701 ¹	MOVITALK MT209 (FuG11b)
¹ Interested in this product? Please contact us for more information.		

Connector for Harris / Macom

	part number	for device
	1801	LPE-200 PRISM / LPE-210
	1802	MRK I / MRK II / MRK III
	1803	JAGUAR 700P / JAGUAR 700PI / P5100 / P5130 / P5150 / P5200 / P5300 / P5400 / P7100 / P7130 / P7150 / P7170 / P7200 / P7270 / P7300 / P7400 / Unity XG-75

Connector for HYT / Hytera

	part number	for device
	0801	HYT2100 / PD502 / PD562 / TC-500 / TC-508 / TC-518 / TC-600 / TC-610 / TC-620 / TC-700 / TC-700EX / TC-700EX+ / TC-800 / TC-850 / TC-900 / TC-980 / TC-1600 / TC-2108 / TC-2100 / TC-2110 / TC-3000 / TC-3600
	0802	BD502 / HYT2100 / PD4-Series PD405 / PD412 / PD415 / PD5-Series PD500 / PD502 / PD505 / PD505LF / PD506 / PD508 / PD562 / PD565 / POWER446 / TC-446S / TC-500 / TC-508 / TC-510 / TC-518 / TC-518 OBR / TC-580 / TC-585 / TC-600 / TC-610 / TC-618 / TC-620 / TC-626 / TC-700 / TC-700EX / TC-1600 / TC-2100 / TR200 / TR400 / Titan
	0803	PD7-Series PD702(G) / PD705(G) / PD752(G) / PD755(G) / PD782(G) / PD785(G) / PD982 / PD985 / PT580H / PT580H+ / PT580H UL913
	0804	PD6-Series (PD605(G) / PD665(G) / PD685(G)) / PD602(G) / PD662(G) / PD682(G) / X1-Series (X1e / X1p / Z1p)
	0805	PD3-Series PD352 / PD355(LF) / PD358 / PD362 / PD365(LF) / PD368 / PD372 / PD375 / PD378
	0105	PT-790 / TC-370M / TC-380M / TC-610P / TC-700P / TC-710 / TC-780 / TC-780M / TC-780MPT / TC-790 / TC-880GM / TC-3000 / TC-3600 / TC-3600 (FuG11b) / TC-3600M
	0106	TC-310 / TC-320 / TC-1688
	0104	TC-980



Connector for Icom

	part number	for device
	0901	IC-02AT / IC-03AT / IC-04AT / IC-2GAT / IC-2GXAT / IC-80AD / IC-91A / IC-91AD / IC-92AD / IC-112 / IC-4008 / IC-4008A / IC-4088 / IC-4088A / IC-4088E / IC-4088SR / IC-5008 / IC-E90 / IC-F3 / IC-F3S / IC-F4 / IC-F4S / IC-F4TR / IC-F10 / IC-F20 / IC-F30G / IC-F31 / IC-H2 / IC-H6 / IC-H16 / IC-J12 / IC-M5 / IC-Q7A / IC-T02AT / IC-T2H / IC-T7H / IC-T22A / IC-T22E / IC-T42A / IC-T42E / IC-T70A / IC-T90 / IC-T90A / IC-TH7H / IC-U12 / IC-U16 / IC-W32A
	0903	BC100 / IC-F3 / IC-F3G / IC-F3GS / IC-3GT / IC-F3S / IC-F4 / IC-F4G / IC-F4GS / IC-F4GT / IC-F4S / IC-F11 / IC-F11S / IC-F12 / IC-F14 / IC-F14S / IC-F15 / IC-F15S / IC-F21 / IC-F21BR / IC-F21GM / IC-F21S / IC-F22 / IC-F24 / IC-F24S / IC-F25 / IC-F25S / IC-F25SR / IC-F31 / IC-F31GS-L / IC-F31GT-L / IC-F33 / IC-F34 / IC-F34GS / IC-F34GT / IC-F43 / IC-F43GS / IC-F43GT / IC-F43TR / IC-F44GS MT / IC-F44GT MT / IC-F3001 / IC-F3011 / IC-F3021 / IC-F3021S / IC-F3021T / IC-F3022S / IC-F3022T / IC-F3026S / IC-F4001 / IC-F4011 / IC-F4021 / IC-F4021S / IC-F4021T / IC-F4026 / IC-F4029SDR / IC-G3GT / IC-U82 / IC-V8 / IC-V80 / IC-V80E / IC-V82 / ID-31E / ID-31A
	0905	IC-F30 / IC-F30G / IC-F30GS / IC-F30GT / IC-F31 / IC-F31G / IC-F31GS / IC-F31GS-L / IC-F31GT / IC-F31GT-L / IC-F40 / IC-F40G / IC-F40GS / IC-F40GT / IC-F41 / IC-F41G / IC-F41GS / IC-F41GT / IC-F50 / IC-F50V / IC-F51 / IC-F51V / IC-F51VPT1 / IC-F60 / IC-F60V / IC-F61 / IC-F61M / IC-F61V / IC-F61VPT1 / IC-F70 / IC-F70D / IC-F70DT / IC-F80 / IC-F80D / IC-F3061 / IC-F3061S / IC-F3061T / IC-F3161 / IC-F3161DS / IC-F3161DT / IC-F3161S / IC-F3161T / IC-F3162 / IC-F3162S / IC-F3261D / IC-F3360D / IC-F3400D / IC-F4061 / IC-F4061S / IC-F4061T / IC-F4161 / IC-F4161DS / IC-F4161DT / IC-F4161S / IC-F4161T / IC-F4162 / IC-F4162DT / IC-F4162S / IC-F4162T / IC-F4261D / IC-F4360D / IC-F4400D / IC-F9011 / IC-F9021 / IC-M87 / IC-M88
	0906	BC100 / IC-F3G / IC-F3GS / IC-F3GT / IC-F4G / IC-F4GS / IC-F4GT / IC-F11 / IC-F11S / IC-F14 / IC-F14S / IC-F15 / IC-F15S / IC-F16 / IC-F20GS / IC-F21 / IC-F21BR / IC-F21GM / IC-F21S / IC-F22 / IC-F24 / IC-F24S / IC-F25 / IC-F25S / IC-F26 / IC-F29SR / IC-F31 / IC-F31G / IC-F31W / IC-F33 / IC-F33G / IC-F33GS / IC-F33GT / IC-F34 / IC-F34G / IC-F34GS / IC-F34GT / IC-F41 / IC-F41W / IC-F43 / IC-F43G / IC-F43GS / IC-F43GT / IC-F43TR / IC-F44GS / IC-F44GT / IC-F51 / IC-F302IT / IC-F302S / IC-F402IT / IC-F402S / IC-F1000 / IC-F1000D / IC-F1000S / IC-F1000T / IC-F2000 / IC-F2000D / IC-F2000S / IC-F2000T / IC-F3000 / IC-F3001 / IC-F3002 / IC-F3003 / IC-F3011 / IC-F3013 / IC-F3021 / IC-F3021S / IC-F3021T / IC-F3022S / IC-F3022T / IC-F3023S / IC-F3023T / IC-F3026 / IC-F3026S / IC-F3026T / IC-F3031 / IC-F3031S / IC-F3032S / IC-F3033S / IC-F3036S / IC-F3062 / IC-F3101D / IC-F3102D / IC-F3103D / IC-F3230DS / IC-F3230DT / IC-F4000 / IC-F4001 / IC-F4002 / IC-F4003 / IC-F4011 / IC-F4013 / IC-F4021 / IC-F4021S / IC-F4021T / IC-F4022S / IC-F4022T / IC-F4023S / IC-F4023T / IC-F4026 / IC-F4026S / IC-F4026T / IC-F4029SDR / IC-F4031 / IC-F4031S / IC-F4032S / IC-F4033S / IC-F4036S / IC-F4101D / IC-F4102D / IC-F4103D / IC-F4230 / IC-F4230DS / IC-F4230DT / IC-G3GT / IC-T3H / IC-T7H / IC-U82 / IC-V8 / IC-V80 / IC-V80E / IC-V82 / IC-V85 / IC-V88
	0912	IC-F3G / IC-F11 / IC-F33 / IC-T3H / IC-V8
	0913	IC-F31W / IC-41W / IC-F1000 / IC-F1000D / IC-F2000 / IC-F2000D / IC-F3031S / IC-F3032S / IC-F3033S / IC-F3036S / IC-F3230D / IC-F4031S / IC-F4032S / IC-F4033S / IC-F4036S / IC-F4230D / IC-V88
	0914	IC-F3260 / IC-F3261 / IC-F3261D / IC-F3261DS / IC-F3261DT / IC-F3262 / IC-F3262DS / IC-F3262DT / IC-F3263 / IC-F3263D / IC-F3263DS / IC-F3263DT / IC-F3360D / IC-F3400D / IC-F3400DS / IC-F3400DT / IC-F4260 / IC-F4261 / IC-F4261D / IC-F4261DS / IC-F4261DT / IC-F4262 / IC-F4262DS / IC-F4262DT / IC-F4263 / IC-F4263D / IC-F4263DS / IC-F4263DT / IC-F4360D / IC-F4400D / IC-F4400DS / IC-F4400DT / IC-F9011 / IC-F9011B / IC-F9011S / IC-F9011T / IC-F9021 / IC-F9021B / IC-F9021S / IC-F9021
	0915	ID-31 / ID-51 / ID-51A Plus / ID-51E Plus
	7045	IC-F110 / IC-F110S / IC-F121 / IC-F121S / IC-F210 / IC-F210S / IC-F221 / IC-F221S / IC-F310 / IC-F310S / IC-F320 / IC-F320S / IC-400PRO / IC-F410 / IC-F410S / IC-F420 / IC-F420S / IC-F510 / IC-F520 / IC-F521 / IC-F610 / IC-F620 / IC-F620TR / IC-F621 / IC-F621TR / IC-F1020 / IC-F1710 / IC-F1721 / IC-F1721D / IC-F1810 / IC-F1821 / IC-F1821D / IC-F2020 / IC-F2710 / IC-F2721 / IC-F2721D / IC-F2810 / IC-F2821 / IC-F2821D / IC-F5021 / IC-F5061 / IC-F6021 / IC-F6061 / IC-F9511 / IC-F9511HT / IC-F9521

Connector for Jabra

	part number	description
	1045	QD-Systemconnector (Quick Disconnect)

Connector for Kenwood

	part number	for device
	0201	NX-220 / NX-240 / NX-320 / NX-340 / NX-420 / PMR-446 / TH-21 / TH-21AT / TH-21BT / TH-22 / TH-22A / TH-22AT / TH-22E / TH-25 / TH-26 / TH-27 / TH-28 / TH-28A / TH-31 / TH-31AT / TH-31BT / TH-41AT / TH-41BT / TH-42 / TH-42A / TH-42AT / TH-42E / TH-45 / TH-46 / TH-47 / TH-48 / TH-48A / TH-55 / TH-75 / TH-77 / TH-77A / TH-78A / TH-79E / TH-205 / TH-215 / TH-225 / TH-235 / TH-235A / TH-235E / TH-315 / TH-3230 / TH-D7 / TH-D7A / TH-D7AG / TH-D7E / TH-D7E-G2.0 / TH-D72A / TH-D72E / TH-D74E / TH-F6 / TH-F6A / TH-F7 / TH-F7E / TH-G71 / TH-G71A / TH-G71E / TH-K2 / TH-K2A / TH-K2AT / TH-K2E / TH-K2ET / TH-K4 / TH-K4A / TH-K4E / TH-K4ET / TH-K20A / TH-K20E / TH-K21A / TH-K40E / TK-208 / TK-220 / TK-240 / TK-240D / TK-248 / TK-250 / TK-260 / TK-260D / TK-260G / TK-261 / TK-270 / TK-270G / TK-272G / TK-308 / TK-320 / TK-327G / TK-340 / TK-340D / TK-348 / TK-350 / TK-350G / TK-353 / TK-360 / TK-360G / TK-361 / TK-370 / TK-370G / TK-372G / TK-373 / TK-373G / TK-378G / TK-430 / TK-431 / TK-2000E / TK-2100 ProTalk / TK-2101 / TK-2102 ProPower / TK-2130 ProTalk XLS / TK-2160E ProPower / TK-2170E ProPower / TK-2200 ProTalk / TK-2200LP / TK-2202CPL / TK-2202E / TK-2207 / TK-2212 / TK-2300 / TK-2300VP / TK-2302E / TK-2302VK / TK-2306 / TK-2307 / TK-2312E / TK-2317 / TK-2360E / TK-2400UK / TK-2400VK / TK-2402UK / TK-2402VK / TK-3000E / TK-3100 ProTalk / TK-3101 FreeTalk XL / TK-3102 ProPower / TK-3130 ProTalk XLS / TK-3131 FreeTalk XLS / TK-3160E ProPower / TK-3170E ProPower / TK-3173 / TK-3200 ProTalk / TK-3200LP / TK-3201 ProTalk / TK-3202E / TK-3207 / TK-3212 / TK-3212L / TK-3230 / TK-3300 / TK-3300VP / TK-3301E / TK-3302E / TK-3302UK / TK-3306 / TK-3307 / TK-3312E / TK-3317 / TK-3350 / TK-3360E / TK-3400 / TK-3401DE / TK-3402 / TK-3501DT / TK-3501E / TK-3501T / TK-5210 / TK-5400 / TK-5410 / TK-D240E / TK-D240FN / TK-D340E / UBZ-LF15 / UBZ-LH68 / UBZ-LJ8 BE / UBZ-LJ8 SLE / UBZ-LJ8 YE
	0202	NX-200E / NX-200GE / NX-200K / NX-200SE / NX-210 / NX-230EX / NX-300E / NX-300GE / NX-300K / NX-300SE / NX-330EX / NX-410K / NX-411 / NX-420 / NX-3200 / NX-3220 / NX-3300 / NX-3320 / NX-5200E / NX-5300E / NX-5400 / P25 / TK-190 / TK-280 / TK-290 (FuG11b) / TK-380 / TK-385 / TK-390 / TK-480 / TK-481 / TK-2140 / TK-2140E / TK-2180D / TK-2180E / TK-2180K / TK-2185E / TK-2260EX ATEX / TK-3140 / TK-3140E / TK-3148 / TK-3180 / TK-3180D / TK-3180E / TK-3180K / TK-D200E / TK-D200E2 / TK-D200GE / TK-D200GE2 / TK-D240E / TK-D300E / TK-D300E2 / TK-300GE / TK-D300GE2 / TK-D340E / TK-5210 / TK-5220 / TK-5310 / TK-5320 / TK-5400 / TK-5410
	0203	PKT-23E
	0204	WD-K10 Series (WD-K10PB SE / WD-K10 TRE)



Connector for Kyodo

	part number	for device
	0701 ¹	KG-209

¹Interested in this product? Please contact us for more information.















Connector for Maxon

	part number	for device
	1991	PL1145 / PL2215P / PL2245 / PL2245P / PL2415 / PL2445 / PL5151 / PL5161 / PL5164 / SL25 / SL55 / SL55Plus / SL70 / SL100 / SL100K / SL120 / SL130 / SL140 / SL200 / SL2215 / SL2245 / SL2245P / SL2415 / SL2445 / SL5151 / SL5161 / SL5164 / SP100 / SP120 / SP130 / SP140 / SP200 / SP200K / SP210 / SP300 / SP310 / SP320 / SP330 / SP340 / SP410
	1992	75-440 / 75-785 / 80-400 / G-225 / G-227 / G-300 / GTX-200 / GTX-250 / GTX-300 / GTX-325 / GTX-400 / GTX-444 / GTX-450 / GTX500VP / PL1145 / PL2215 / PL2245 / PL24125 / PL2445 / SL25 / SL55 / SL55Plus / SP100 / SP120 / SP130 / SP140 / SP300 / SP310 / SP320 / SP330 / SP340
	1994	PL1145 / PL2215P / PL2245 / PL2245P / PL2415 / PL2445 / PL2445P / PL5151 / PL5161 / PL5164 / SL100 / SL200 / SL200K / SP200 / SP200K / SP210 / SP210K / SP220K / TSL100 (FuG11b) / TruTalk MURS-22 / TruTalk MURS-25

Connector for Motorola

	part number	for device
	0101	AP10 / AP50 / AP73 / AU1200 / AV1200 / AXU4100 / AXV5100 / BC10 / BC90 / BC120 / BC130 / BPR20 / BPR40 / BPR250 / BPR400 / CLS446 / CLS1110 / CLS1410 / CLS1413 / CLS1450C / CLS1453C / CP040 / CP080 / CP88 / CP100 / CP110 / CP125 / CP140 / CP150 / CP160 / CP180 / CP185 / CP200 / CP200D / CP200XLS / CP220 / CP240 / CP250 / CP300 / CP1225 / CP1660 / CT125 / CT150 / CT250 / CT450 / CT450LS / DEP450 / DP1000 / DP1400 / DTR410 / DTR450 / DTR510 / DTR550 / DTR610 / DTR620 / DTR650 / DTR2430 / DTR2450 / ECP100 / EP450S / GP68 / GP88S / GP200 / GP280 / GP300 / GP308 / GP350 / GP600 / GP2000 / GP2100 / GP3188 / GP3688 / GTI2000 / GTX2000 / GTX Portable / GTX LTR Portable / GTX Privacy Plus Portable / Handie Pro Series / HT850 / LTS2000 / MTH500 / P10 / P50Plus / P040 / P080 / P100 / P110 / P200 / P1225LS / P2000 / PMR446 / PR400 / PTX600 / PRO1150 / PRO2150 / PRO3150 / PRO5150 / S100 / S200 / S220 / S240 / RDM2020 / RDM2070D / RDU2020 / RDU2080D / RDU4100 / RDU4160D / RDV2020 / RDV2080D / RDV5100 / RMM2050 / RMU2040 / RMU2043 / RMU2080D / SP10 / SP21 / SP50Plus / Spirit HP 10 / Spirit MU11CV / Spirit MU12CV / Spirit MU21CV / Spirit MU22CVS / Spirit MU24CVST / Spirit MV11CV / Spirit MV12CV / Spirit MV21CV / Spirit MV22CVS / Spirit Pro / Spirit Pro Plus / Spirit SU22C / Spirit SU220 / Spirit SV10 / Spirit SV11D / Spirit SV21 / Spirit SV22C / VL50 / VL130 / XT420 / XT460 / XTN446 / XTN500 / XTN600 / XTNiD / XTR446 / XU50 / XU1100 / XU2100 / XU2600 / XU4100 / XV1100 / XV1400 / XV2100 / XV2600 / XV4100
	0102	VISAR Series
	0103	GP900 (FuG11b) / GP1200 / GP9000 / HT1000 / HT1100 / HT2000 / JT1000 / MOF230 / MT1000 / MT1500 / MT2000 / MT2100 / MT6000 / MTC900 / MTP200 / MTP300 / MTS1000 / MTS1200 / MTS2000 / MTS2010 (FuG10b) / MTS2013 (FuG13b) / MTX838 / MTX868 / MTX900 / MTX960 / MTX1000 / MTX2000 / MTX8000 / MTX9000 / MTX-B5 / MTX-B7 / MTX-LS / PR1500 / PTX1200 / PTX3600 / XTS1500 / XTS2000 / XTS2250 / XTS2500 / XTS3000 / XTS3000R / XTS3500 / XTS4250 / XTS5000 / XTS5000R / XTS5100 / XTS7700
	0104	GP140 / GP240 / GP280 / GP320 / GP328 / GP329 / GP330 / GP338 / GP339 / GP340 / GP350 / GP360 (FuG11b) / GP380 (FuG11b ATEX) / GP385 (FuG10b) / GP386 / GP540 / GP580 / GP600 / GP620 / GP640 / GP650 / GP660 / GP680 / GP760 / GP960 / GP1280 / HT750 / HT1250LS / HT1550XLS / MTP700 / MTP810EX (Tetra) / MTX850LS / MTX900 / MTX950 / MTX960 / MTX1500 / MTX8250LS / MTX9250 / PR860 / PRO5150 / PRO5350 / PRO5450 / PRO5550 / PRO5750 / PRO7150 / PRO7350 / PRO7450 / PRO7550 / PRO7750 / PRO9150 / PTX700 / PTX760 / PTX780 / R765 / Waris Series
	0105	EX500 / EX560XLS / EX600XLS / GL200 / GL2000 / GP328+ / GP329+ / GP338+ / GP339+ / GP344 / GP388 / GP628+ / GP638+ / GP644 / GP680 / GP688 / PRO5150 / PRO5151 / PRO5250 / PRO5350 / PRO5550 / PRO7150 / PRO7250 / PRO7350 / PRO7550 / PTX700+ / PTX760+



part number	for device
	0106 SPIRIT GT / SPIRIT GT+ / TalkAbout Series EM1000R / EM1020R / FR50 / FR60 / FRS50 / FRS60 / FRS5512 / FRS5522 / FV200 / FV300AA / FV300R / FV500 / FV600 / FV700R / FV750R / FV800 / MB140R / MC220R / MC225R / MD200TPR / MD207R / MG160A / MG167A / MH230TPR / MHP61 / MHP71 / MHP81 / MJ270R / MJ430R / MR350TPR / MR351 / MR355R / MR560R / MS350R / MT350TPR / MT352TPR / MT355R / MU350R / MU354R / RT210 / SX500 / SX600R / SX620R / SX700R / SX750 / SX790R / SX800R / SX900R / SX920R / T200 / T260 / T270 / T280 / T289 / T400 / T460 / T465 / T480 / T550 / T600 / T605 / T4300 / T4500 / T4502 / T4508 / T4525 / T4700R / T4800 / T4900 / T4905 / T5000 / T5022 / T5100 / T5200 / T5300 / T5320 / T5340 / T5400 / T5410 / T5420 / T5422 / T5428 / T5432 / T5500 / T5512 / T5522 / T5530 / T5530R / T5532 / T5600 / T5620 / T5622 / T5625 / T5628 / T5700 / T5710 / T5720 / T5725 / T5800 / T5820 / T5900 / T5920 / T5950 / T6000 / T6100 / T6200 / T6210 / T6220 / T6222 / T6250 / T6300 / T6310 / T6320 / T6400 / T6500 / T6530 / T6550 / T6600 / T6700 / T6800 / T6900 / T7100 / T7200 / T7300 / T7400 / T7500 / T7600 / T7700 / T7800 / T8500 / T8500R / T8550 / T9100 / T9500XLR / T9550XLR / T9580XLR / T9680R / T9750R / TKLR T3 / TKLR T4 / TLKR T5 / TLKR T7 / TLKR T8 / TLKR T9 / TLKR T60 / TLKR T80 Extreme / XTL446 / XTR446
	0107 ASTRO SABER / MX1000 / MX1010 / MX2000 / MX3000 Series (MX3010 / MX3013) / MX3013 (FuG10b) / MX3013 (FuG13b) / PRV-7500 / SABER I / SABER II / SABER III
	0108 EWP1000 / EWP1100 / EWP2000 / EWP2100 / MTH500 / MTH600 / MTH650 / MTH800 / MTP850 / Nextel Falcon Series i30sx / i35s / i205 / i215 / i265 / i275 / i285 / i290 / i296 / i305 / i315 / i325 / i335 / i355 / i365 / ic402 / i410 / i412 / i415 / i450 / Clutch i465 / ic502 / i530 / i560 / i570 / i576 / i580 / ic602 / i605 / i615 / i670 / BRUTE i686 / i710 / i720 / i730 / i733 / i736 / i740 / i760 / i776 / i830 / i833 / i835 Roxy / i836 / i850 / i855 / i860 Woody/Tattoo / i870 / i875 / i876 / i880 / ic902 / i920 / i930 / Titanium / XTS4000
	0109 CEP400 / MTH500 / MTH600 / MTH650 / MTH800 / MTH850 / MTP650 / MTP850 / MTP850A / MTP850S Series / XTS7000
	0110 MOTOTRBO APX1000 / APX2000 / APX3000 / APX4000XH / APE6000XE / APX7000L / APX7000SE / APX7000XE / APX7500 / APX8000XE / DGP4150Plus / DGP5050 / DGP5550 / DGP6150Plus / DGP8050 / DGP8550 / DP3400 / DP3401 / DP3600 / DP3601 / DP4150 / DP4400(e) / DP4401(e) / DP4600(e) / DP4601(e) / DP4800(e) / DP4801(e) / DP6150 / MTP-830FuG / MTP830S / MTP850FuG / MTP850S / MTP6550 / MTP6750 / SRX2200 / XiR8200 / XiR P8208 / XiR P8260 / XiR P8268 / XiR P8600 / XiR P8608 / XiR P8620 / XiR P8628 / XiR P8660 / XiR P8668 / XPR4500 / XPR6000 / XPR6100 / XPR6300 / XPR6350 / XPR6380 / XPR6500 / XPR6550 / XPR6580 / XPR7000 / XPR7350 / XPR7380 / XPR7550 / XPR7580
	0111 CLP Series (CLP107 / CLP117 / CLP446 / CLP1010 / CLP1040 / CLP1060) & CLK446
	0112 NNTN8191 Wireless PTT
	0113 SL1K / SL300 / SL1600 / SL2600 / SL4000 / SL4010 / SL7550 / SL7550e / SL7580e / SL7590 / SL7590e
	0114 MOTOTRBO DEP550 / DEP570 / DP2000(e) Series (DP2400(e) / DP2600(e)) / DP3441 / MTP3000 / MTP3100 / MTP3150 / MTP3200 / MTP3250 / MTP3500 / MTP3550 / XiR P6600 / XiR P6608 / XiR P6620 / XiR P6628 / XPR3000 / XPR3300 / XPR3500
	0140 WT40XX / WT41XX
	0143 Bluetooth Pod PMLN6396A / HKLN4512
	7045 CDM750 / CDM1250 / CDM1550 / CM200 / CM300 / GM Series / Maxtrac Series / MCS2000





Connector for BATSTAR Wireless Earphone Connection Kit

	part number	for device
	0112 ¹	BATSTAR Bluetooth® Connector
		¹ also compatible with Motorola NNTN8191 wireless PTT



Connector for Peltor

	part number	description
	7304	7.3 mm straight Nexus Audio Connector 4-pole
	7305	7.3 mm straight Nexus Audio Connector 5-pole



Connector for Raxon

	part number	for device
	3288	RL-308 / RL-328 / RL-328 Plus / RL-328CQ / RL-328CQ Plus / RL-328K / RL-328S
	3289 ¹	RL-328 Plus (4m) / RL-328 Plus (2m) / RL-328S (4m) / RL-328S (2m) / LIS2010 (FuG10b) / LIS2011 (FuG11b) / LIS2013 (FuG13b)
		¹ not compatible with RL-328CQ

Connector for Samsung

	part number	for device
	4101 ¹	S2 / S3 / S3 Mini / S4 / S5
	4102 ¹	S2 / S3 / S3 Mini / S4 / S5
		¹ also compatible with HTC ONE / Sony Xperia Ion

Connector for Savox

	part number	description
	7204	7.3 mm straight Nexus Audio Connector 4-pole
	7205	7.3 mm straight Nexus Audio Connector 5-pole







Connector for Sepura

	part number	for device
	2802	SRP2000 / SRP3000 / SRH3500 / SRH3800 / SRH3900
	2808	SC2020 / STP8000 Series (STP8100 / STP8200 / STP8038) & STP9000 Series (STP9100 / STP9200 / STP9038)

Connector for Simoco



	part number	for device
	2708	SRP8020 / SRP8030 / SRP9120 / SRP9130
	2709	SRP9000 / SRM9000

Connector for Vertex



	part number	for device
	0901	FT-10R / FT-40R / FT-50R / FT-60R / T90 / VX-1R / VX-2E / VX-2R / VX-5R / FT-270 / VX-120 / VX-127 / VX-170 / VX-177 / VX-200 / VX-500 / VX-510 / VX-520UD / VX-6R / VX-7R
	0492	VX-200 / VX-310 / VX-500 / VX-510 / VX-520 / VX-520UD
	0402	CX-410 / CX-420 / EVX-531 / EVX-534 / EVX-539 / FT-1DE / FT-1DRS / FT-10R / FT-40R / FT-50R / FT-60R / FT-250 / VX-1R / VX-2E / VX-2R / VX-3 / VX-5R / VX-8GE / VX-8GR / VX-10 / VX-110 / VX-130 / VX-131 / VX-146 / VX-150 / VX-160 / VX-180 / VX-200 / VX-210A / VX-230 / VX-231 / VX-246 / VX-300 / VX-315 / VX-350 / VX-351 / VX-354 / VX-400 / VX-410 / VX-414 / VX-417 / VX-420 / VX-424 / VX-427A / VX-450 / VX-451 / VX-454 / VX-459 / VX-800 / VX-FIR / VXF-1 / VXF-10 / VXF-20
	0402	MH-360M / MH-450M / MH-507A / VH-110 / VH-115M / VH-120 / VH-130 / VH-215M / VH-225M / VX-530 / VX-537 / VX-600 / VX-800 / VX-900
	0403	EVX-261 / EVX-510 / EVX-530 / EVX-531 / EVX-534 / EVX-539 / VX-110 / VX-130 / VX-131 / VX-132 / VX-150 / VX-151 / VX-160 / VX-180 / VX-200 / VX-210A / VX-230 / VX-231 / VX-260 / VX-261 / VX-264 / VX-300 / VX-350 / VX-351 / VX-354 / VX-400 / VX-410 / VX-420 / VX-427 / VX-451 / VX-454 / VX-459
	0404	EVX-530 / EVX-531 / EVX-534 / VX-130 / VX-131 / VX-132 / VX-146 / VX-160 / VX-180 / VX-210A / VX-230 / VX-231 / VX-241 / VX-246 / VX-315 / VX-350 / VX-351PMR / VX-354 / VX-400 / VX-410 / VX-417 / VX-420 / VX-424 / VX-427A / VX-450 / VX-451 / VX-454 / VX-459
	0405	VX-820 / VX-821 / VX-824 / VX-829 / VX-871 / VX-874 / VX-879 / VX-920 / VX-921 / VX-924 / VX-925 / VX-929 / VX-971 / VX-974 / VX-979 / VX-P820 / VX-P821 / VX-P824 / VX-P829 / VX-P871 / VX-P874 / VX-P920 / VX-P921 / VX-P924 / VX-P929 / VX-P971 / VX-P974 / VX-P979 / VXD-720
	0406	EVX-S24 / FT-270E / VX-6 / VX-6E / VX-6R / VX-7 / VX-7E / VX-7R / VX-7RB / VX-120 / VX-127 / VX-170 / VX-177









Connector for Topsystem Voxter®

	part number	description
	1051	5-pin Binder-Systemconnector
	1059	5-pin Binder-System Jack
	1091	9-pin ODU Connector

Connector for proLogistik pL-Voice

	part number	description
	1031	5-pin Binder-Systemconnector
	1039	5-pin Binder-System Jack

Connector for BATSTAR Audio Solutions

	part number	description
	1047	Thread Connector 4-pole
	1057	Thread Connector 5-pole
	1061	6-pin HiRose-Systemconnector
	1069	6-pin HiRose-System Jack
	1121	12-pin HiRose-Systemconnector
	1129	12-pin HiRose-System Jack

Connector for Vocollect-Talkman®



part number	for device
5002	Vocollect-Talkman®-Systemconnector (Yellow Slot)
5003	Vocollect-Talkman®-Systemconnector inclusive "Operator ID Recognition" (Yellow Slot)
5008	Vocollect-Talkman® Audio Systemconnector (Red Slot)
5009	Vocollect-Talkman® Data Transfer Systemconnector (Blue Slot)

Connector for BATSTAR Acoustic Tube Solutions¹



part number	description
5301	Dual-Pin Connector
5309	Dual-Pin Jack

¹not compatible with Earphone Acoustic Tube „Silver“ (5 X35X)

XLR Connector



part number	description
6001	Mini XLR Connector



INTELLIGENT

Clever

Progressive

INDEPENDENCE

Energy

Sustainable

Quality

UNIQUE

Service

Improve

CONFIDENCE

Experience

Solution

Flexible

BATSTAR GmbH
Ungerather Str. 87
D-41366 Schwalmatal

Telefon: +49(0)2163/57556-0
Telefax: +49(0)2163/57556-50

E-Mail: info@batstar.de
[http:// www.batstar.de](http://www.batstar.de)
Shop: www.batstar24.de



Download digital version